

# JVC

## DIGITAL VIDEO CAMERA

# GR-DF570

# GR-DF470

# GR-DF430

Please visit our Homepage on the World Wide Web for Digital Video Camera:

<http://www.jvc.co.jp/english/cyber/>

For Accessories:

<http://www.jvc.co.jp/english/accessory/>

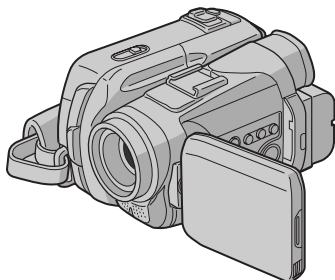

Mini **DV** PAL



*MultiMediaCard*

The camcorder illustrations appearing in this instruction manual are of the GR-DF570.

The D.S.C (Digital Still Camera) features are available on GR-DF570 and GR-DF470.

**Dear Customer,**

Thank you for purchasing this digital video camera. Before use, please read the safety information and precautions contained in the pages 3 – 4 and 10 to ensure safe use of this product.

**ENGLISH**

**GETTING STARTED 6**

**VIDEO RECORDING & PLAYBACK 19**

**DIGITAL STILL CAMERA (D.S.C.) RECORDING & PLAYBACK (GR-DF570/470 only) 28**

**ADVANCED FEATURES 37**

**REFERENCES 57**

**TERMS 66**

To deactivate the demonstration, set "DEMO MODE" to "OFF".  
(☞ pg. 37, 40)

## INSTRUCTIONS

LYT1394-001A

**EN**

## Major Features of this Camcorder

### Wipe/Fader Effects

You can use the Wipe/Fader Effects to make pro-style scene transitions. (☞ pg. 48)

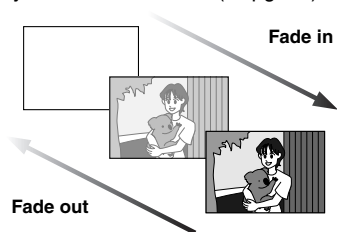

### Program AE with Special Effects

For example, "SPORTS" mode allows fast-moving images to be captured one frame at a time, for vivid, stable slow-motion. (☞ pg. 48)

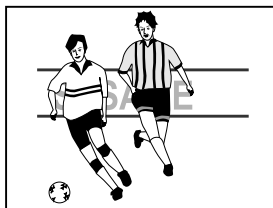

### Biphonic Recording/Playback\*

Put on the Mic for Biphonic (connected to the camcorder) to your ears like in-the-ear type headphones during shooting, and activate Biphonic feature during playback. No special audio systems are not required and any conventional TV, VCR, or stereo system is enough to reproduce real three-dimensional acoustic fields utilizing Biphonic Recording and Playback features. (☞ pg. 24, 51)

### Backlight Compensation

Simply pressing the **BACK LIGHT** button brightens the image darkened by backlight. (☞ pg. 46)

- You can also select a spot metering area so that more precise exposure compensation is available. (☞ pg. 46, Spot Exposure Control)

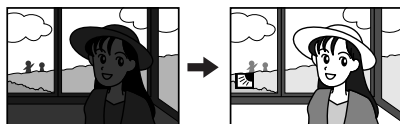

### Navigation Function\*

The Navigation Function helps you check tape contents by making thumbnail images on a memory card. (☞ pg. 49)

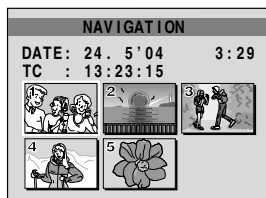

### E-Mail Clip Recording\*

You can record video clips on the memory card as files which can be sent via e-mail. (☞ pg. 32)

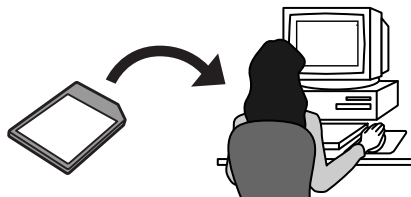

\* GR-DF570/470 only

## SAFETY PRECAUTIONS

**WARNING: TO PREVENT FIRE OR SHOCK HAZARD, DO NOT EXPOSE THIS UNIT TO RAIN OR MOISTURE.**

### CAUTIONS:

- If you notice smoke or a peculiar smell coming from the camcorder or AC Adapter, shut it down and unplug it immediately. Continue using the camcorder or AC Adapter under these conditions could lead to fire or electric shock. Contact your JVC dealer. Do not attempt to repair the malfunction yourself.
- To prevent shock, do not open the cabinet. No user serviceable parts inside. Refer servicing to qualified personnel.
- When you are not using the AC Adapter for a long period of time, it is recommended that you disconnect the power cord from AC outlet.

### CAUTION:

To avoid electric shock or damage to the unit, first firmly insert the small end of the power cord into the AC Adapter until it is no longer wobbly, and then plug the larger end of the power cord into an AC outlet.

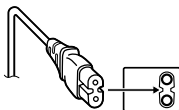

### CAUTIONS:

- This camcorder is designed to be used with PAL-type colour television signals. It cannot be used for playback with a television of a different standard. However, live recording and LCD monitor/viewfinder playback are possible anywhere.
- This product includes patented and other proprietary technology and will operate only with JVC Data Battery. Use the JVC BN-VF707U/VF714U/VF733U battery packs and, to recharge them or to supply power to the camcorder from an AC outlet, use the provided multi-voltage AC Adapter. (An appropriate conversion adapter may be necessary to accommodate different designs of AC outlets in different countries.)

### Caution on Replaceable lithium battery

The battery used in this device may present a fire or chemical burn hazard if mistreated.

Do not recharge, disassemble, heat above 100°C or incinerate.

Replace battery with Panasonic (Matsushita Electric), Sanyo, Sony or Maxell CR2025.

Danger of explosion or Risk of fire if the battery is incorrectly replaced.

- Dispose of used battery promptly.
- Keep away from children.
- Do not disassemble and do not dispose of in fire.

### NOTES:

- The rating plate (serial number plate) and safety caution are on the bottom and/or the back of the main unit.
- The rating information and safety caution of the AC Adapter are on its upper and lower sides.

When the equipment is installed in a cabinet or on a shelf, make sure that it has sufficient space on all sides to allow for ventilation (10 cm or more on both sides, on top and at the rear).

Do not block the ventilation holes. (If the ventilation holes are blocked by a newspaper, or cloth etc. the heat may not be able to get out.)

No naked flame sources, such as lighted candles, should be placed on the apparatus.

When discarding batteries, environmental problems must be considered and the local rules or laws governing the disposal of these batteries must be followed strictly.

The apparatus shall not be exposed to dripping or splashing.

Do not use this equipment in a bathroom or places with water.

Also do not place any containers filled with water or liquids (such as cosmetics or medicines, flower vases, potted plants, cups etc.) on top of this unit. (If water or liquid is allowed to enter this equipment, fire or electric shock may be caused.)

Do not point the lens or the viewfinder directly into the sun. This can cause eye injuries, as well as lead to the malfunctioning of internal circuitry. There is also a risk of fire or electric shock.

**CAUTION!**

The following notes concern possible physical damage to the camcorder and to the user.

When carrying, be sure to always securely attach and use the provided strap. Carrying or holding the camcorder by the viewfinder and/or the LCD monitor can result in dropping the unit, or in a malfunction.

Take care not to get your finger caught in the cassette holder cover. Do not let children operate the camcorder, as they are particularly susceptible to this type of injury.

Do not use a tripod on unsteady or unlevel surfaces. It could tip over, causing serious damage to the camcorder.

**CAUTION!**

Connecting cables (Audio/Video, S-Video, etc.) to the camcorder and leaving it on top of the TV is not recommended, as tripping on the cables will cause the camcorder to fall, resulting in damage.

<b>GETTING STARTED</b> .....	<b>6</b>	<b>ADDITIONAL FEATURES FOR D.S.C. (GR-DF570/470 only)</b> .....	<b>32</b>
Index .....	6	E-Mail Clip Recording .....	32
Provided Accessories .....	11	Dubbing Still Images Recorded On A Tape To A Memory Card .....	33
Power .....	13	Resetting The File Name .....	33
Operation Mode .....	15	Protecting Files .....	33
Language Settings .....	16	Deleting Files .....	34
Date/Time Settings .....	16	Setting Print Information (DPOF Setting) .....	35
Grip Adjustment .....	16	Initialising A Memory Card .....	36
Viewfinder Adjustment .....	16		
Brightness Adjustment Of The Display .....	17	<b>ADVANCED FEATURES</b> .....	<b>37</b>
Tripod Mounting .....	17	<b>MENUS FOR DETAILED ADJUSTMENT</b> .....	<b>37</b>
Loading/Unloading A Cassette .....	17	Changing The Menu Settings .....	37
Loading/Unloading A Memory Card (GR-DF570/470 only) .....	18	Recording Menus .....	38
		Playback Menus .....	41
<b>VIDEO RECORDING &amp; PLAYBACK</b> .....	<b>19</b>	<b>FEATURES FOR RECORDING</b> .....	<b>43</b>
<b>VIDEO RECORDING</b> .....	<b>19</b>	LED Light (GR-DF570/470 only) .....	43
Basic Recording .....	19	Live Slow (GR-DF570/470 only) .....	43
Tape Remaining Time .....	19	5-Second Recording .....	43
LCD Monitor And Viewfinder .....	19	Night-Alive .....	44
Zooming .....	20	Snapshot (For Video Recording) .....	44
Journalistic Shooting .....	20	Manual Focus .....	45
Self Recording .....	20	Exposure Control .....	45
Time Code .....	21	Iris Lock .....	46
Quick Review .....	21	Backlight Compensation .....	46
Recording From The Middle Of A Tape .....	21	Spot Exposure Control .....	46
<b>VIDEO PLAYBACK</b> .....	<b>22</b>	White Balance Adjustment .....	47
Normal Playback .....	22	Manual White Balance Adjustment .....	47
Still Playback .....	22	Wipe Or Fader Effects .....	48
Shuttle Search .....	22	Program AE With Special Effects .....	48
Blank Search .....	22	Navigation Function (GR-DF570/470 only) .....	49
Connections To A TV Or VCR .....	23	Biphonic Recording (GR-DF570/470 only) .....	51
Biphonic Playback (GR-DF570/470 only) .....	24	<b>EDITING</b> .....	<b>52</b>
Playback Using The Remote Control .....	25	Dubbing To Or From A VCR .....	52
		Dubbing To Or From A Video Unit Equipped With A DV Connector (Digital Dubbing) .....	53
<b>DIGITAL STILL CAMERA (D.S.C.) RECORDING &amp; PLAYBACK (GR-DF570/470 only)</b> .....	<b>28</b>	Connection To A Personal Computer .....	54
<b>D.S.C. RECORDING (GR-DF570/470 only)</b> .....	<b>28</b>	Audio Dubbing .....	55
Basic Shooting (D.S.C. Snapshot) .....	28	Insert Editing .....	56
Interval Shooting .....	29		
<b>D.S.C. PLAYBACK (GR-DF570/470 only)</b> .....	<b>30</b>	<b>REFERENCES</b> .....	<b>57</b>
Normal Playback Of Images .....	30	<b>TROUBLESHOOTING</b> .....	<b>57</b>
Auto Playback Of Images .....	30	<b>USER MAINTENANCE</b> .....	<b>61</b>
Playback Of Video Clips .....	30	<b>CAUTIONS</b> .....	<b>62</b>
Index Playback Of Files .....	31	<b>SPECIFICATIONS</b> .....	<b>65</b>
Viewing File Information .....	31		
Removing On-Screen Display .....	31	<b>TERMS</b> .....	<b>66</b>

Index

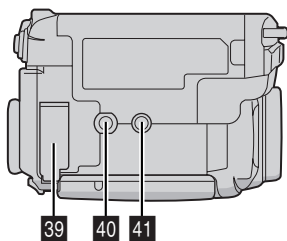
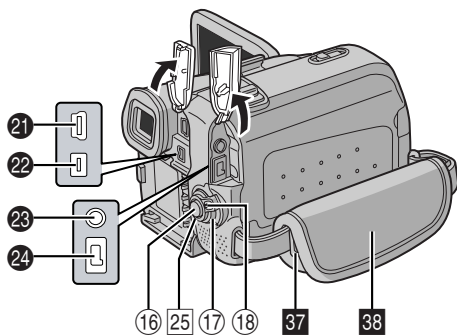
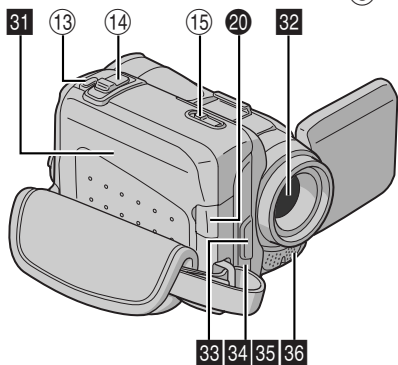
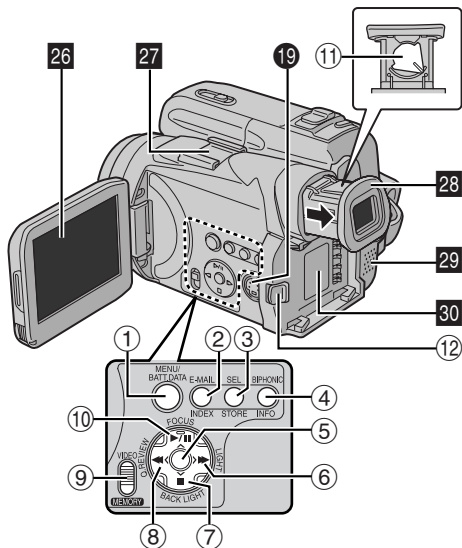

## Controls

- ① Menu Button [MENU] (☞ pg. 37)  
Data Battery Button [BATT. DATA] (☞ pg. 14)
- ② E-Mail Clip Recording Button [E-MAIL]\*  
(☞ pg. 32)  
Index Button [INDEX]\*  
(☞ pg. 31)
- ③ D.S.C. Playback Select Button [SEL]\*  
(☞ pg. 30)  
Thumbnail Storing Button [STORE]\*  
(☞ pg. 49)
- ④ Biphonic Button [BIPHONIC]\*  
(☞ pg. 24)  
Information Button [INFO]\*  
(☞ pg. 31)
- ⑤ Set Button [SET] (☞ pg. 37)
- ⑥ Fast-Forward Button [▶▶] (☞ pg. 22)  
LED Light Button [LIGHT]\*  
(☞ pg. 43)  
Right Button [>] (☞ pg. 37)
- ⑦ Stop Button [■] (☞ pg. 22)  
Backlight Compensation Button [BACK LIGHT] (☞ pg. 46)  
Down Button [v] (☞ pg. 37)
- ⑧ Rewind Button [◀◀] (☞ pg. 22)  
Quick Review Button [Q.REVIEW] (☞ pg. 21)  
Left Button [←] (☞ pg. 37)
- ⑨ VIDEO/MEMORY Switch\*  
(☞ pg. 15)
- ⑩ Play/Pause Button [▶/||] (☞ pg. 22)  
Manual Focus Button [FOCUS] (☞ pg. 45)  
Up Button [Λ] (☞ pg. 37)
- ⑪ Dioptre Adjustment Control (☞ pg. 16)
- ⑫ Battery Release Button [BATT. RELEASE]  
(☞ pg. 14)
- ⑬ Snapshot Button [SNAPSHOT]  
(☞ pg. 28, 44)  
Live Slow Button [SLOW]\*  
(☞ pg. 37, 43)
- ⑭ Power Zoom Lever [T/W] (☞ pg. 20)  
Speaker Volume Control [VOL. +, -]  
(☞ pg. 22)
- ⑮ Cassette Open/Eject Switch [OPEN/EJECT]  
(☞ pg. 17)
- ⑯ Recording Start/Stop Button (☞ pg. 19)
- ⑰ Power Switch [A, M, PLAY, OFF] (☞ pg. 15)
- ⑱ Lock Button (☞ pg. 15)

## Connectors

The connectors are located beneath the covers.

- ⑲ S-Video Input/Output Connector [S]  
(☞ pg. 23, 52)
- ⑳ Microphone connector [MIC] (☞ pg. 38, 55)
- ㉑ USB (Universal Serial Bus) Connector\*  
(☞ pg. 54)
- ㉒ Digital Video (i.Link) Connector [DV IN/OUT]  
(☞ pg. 53, 54)  
i.Link: i.Link refers to the IEEE1394-1995 industry specification and extensions thereof. The  logo is used for products compliant with the i.Link standard.
- ㉓ Audio/Video Input/Output Connector [AV]  
(☞ pg. 23, 52)
- ㉔ DC Input Connector [DC] (☞ pg. 13)

## Indicators

- ㉕ POWER/CHARGE Lamp (☞ pg. 13, 19)

## Other Parts

- ㉖ LCD Monitor (☞ pg. 19, 20)
- ㉗ Shoe  
(Before you purchase optional shoe accessories, make sure the items are compatible and can attach to the shoe on your camcorder. There may be cases where a part of an accessory item protrudes onto the camcorder's body, preventing attachment to your unit.)
- ㉘ Viewfinder (☞ pg. 16)
- ㉙ Speaker (☞ pg. 22)
- ㉚ Battery Pack Mount (☞ pg. 14)
- ㉛ Cassette Holder Cover (☞ pg. 17)
- ㉜ Lens
- ㉝ LED Light\*  
(☞ pg. 43)  
(When using an optional conversion lens, it may cover this area and block the light.)
- ㉞ Remote Sensor (☞ pg. 25)
- ㉟ Camera Sensor  
(Be careful not to cover this area, a sensor necessary for shooting is built-in here.)
- ㊱ Stereo Microphone (☞ pg. 55)
- ㊲ Shoulder Strap Eyelet (☞ pg. 12)
- ㊳ Grip Strap (☞ pg. 16)
- ㊴ Card Cover [MEMORY CARD]\*  
(☞ pg. 18)
- ㊵ Tripod Mounting Socket (☞ pg. 17)
- ㊶ Stud Hole (☞ pg. 17)

\* GR-DF570/470 only

## LCD Monitor/Viewfinder Indications During Video Recording Only

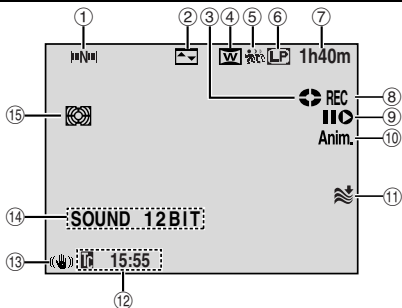

- ① Navigation Indicator\* (☞ pg. 49)
- ② Selected Wipe/Fader Effect Indicator (☞ pg. 48)
- ③ Tape Running Indicator (☞ pg. 19)  
(Rotates while tape is running.)
- ④ Selected Wide Mode Indicator (☞ pg. 39)
- ⑤ : Live Slow Indicator\* (☞ pg. 43)
- ⑥ : Snapshot Indicator (☞ pg. 44)
- ⑦ Recording Speed Mode (SP/LP) (☞ pg. 38)
- ⑧ REC: (Appears during recording.) (☞ pg. 19)  
PAUSE: (Appears during Record-Standby mode.) (☞ pg. 19)
- ⑨ Insert Editing/Insert Editing Pause Mode (☞ pg. 56)
- ⑩ 5S/Anim.: Displays the 5-Second Recording mode or Animation recording mode. (☞ pg. 39)
- ⑪ Wind Cut Indicator (☞ pg. 39)
- ⑫ Time Code (☞ pg. 40, 42)
- ⑬ Digital Image Stabiliser ("DIS") (☞ pg. 39)
- ⑭ SOUND 12BIT/16BIT: Sound Mode Indicator (☞ pg. 38) (Appears for approx. 5 seconds after turning on the camcorder.)  
L : Auxiliary Microphone Level  
R Indicator  
(Appears when an optional microphone is connected. ☞ pg. 40, "AUDIO LEV.")
- ⑮ : Biphonic Recording Mode Indicator\* (☞ pg. 51)

## During D.S.C. Recording Only (GR-DF570/470 only)

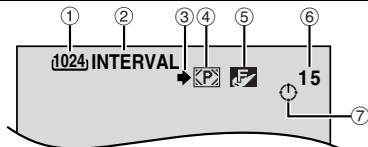

- ① Image Size: 1600 (1600 x 1200)\*, 1152 (1152 x 864)\*, 1024 (1024 x 768) or 640 (640 x 480) (☞ pg. 41)  
\* GR-DF570 only
- ② INTERVAL: Interval Shooting Icon (☞ pg. 28)  
: Focus Icon (☞ pg. 28)
- ③ Shooting Icon (☞ pg. 28)  
(Appears and blinks during shooting.)
- ④ Card Icon (☞ pg. 28)  
: Appears during shooting.  
: Blinks in white when a memory card is not loaded.  
: Blinks in yellow while the camcorder is reading the data in the memory card such as Navigation thumbnail images, video clips, still images, etc.
- ⑤ Picture Quality: (FINE) and (STANDARD) (in order of quality) (☞ pg. 41)
- ⑥ Remaining Number Of Shots (☞ pg. 28)  
(Displays the approximate remaining number of shots that can be stored during D.S.C. recording.)
- ⑦ Clock Icon (☞ pg. 28)

## During E-Mail Clip Recording (GR-DF570/470 only)

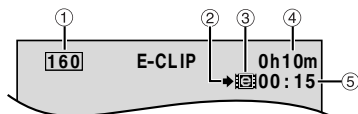

- ① Image Size: 160 (160 x 120)
- ② Shooting Icon (☞ pg. 28, 32)
- ③ E-Mail Clip Recording Indicator (☞ pg. 32)
- ④ Memory Card Remaining Time For E-Mail Clip Recording (☞ pg. 32)
- ⑤ E-Mail Clip Recording Time (☞ pg. 32)

\* GR-DF570/470 only



## During Both Video And D.S.C.\* Recording

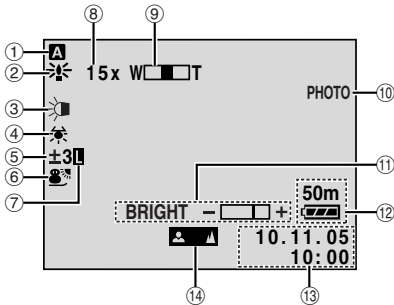

- ① Operation Mode (☞ pg. 15)
- ② **A**: Gain Up Mode (☞ pg. 38)
- ③ LED Light Indicator\* (☞ pg. 43)
- ④ White Balance Indicator (☞ pg. 47)
- ⑤ **S**: Spot Exposure Control Indicator (☞ pg. 46)
- ⑥ **B**: Backlight Compensation Indicator (☞ pg. 46)
- ⑦ **±**: Exposure Adjustment Indicator (☞ pg. 45)
- ⑧ Selected Program AE With Special Effects Indicator (☞ pg. 48)
- ⑨ **N**: Night-Alive Indicator (☞ pg. 44)
- ⑩ **PHOTO**: (Appears when taking Snapshot.) (☞ pg. 29, 44)
- ⑪ **SLOW**: (Appears when using Live Slow.)\* (☞ pg. 43)
- ⑫ Brightness Control Indicator (LCD monitor/Viewfinder) (☞ pg. 17)
- ⑬ Battery Remaining Power Indicator (☞ pg. 59)
- ⑭ Date/Time (☞ pg. 16)
- ⑮ Manual Focus Adjustment Indicator (☞ pg. 45)

## During Video Playback

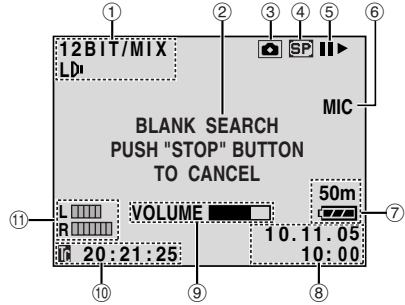

- ① Sound Mode Indicator (☞ pg. 41)
- ② Blank Search Indicator (☞ pg. 22)
- ③ **S**: Live Slow Indicator\* (☞ pg. 43)
- ④ **S**: Snapshot Indicator (☞ pg. 44)
- ⑤ **▶▶**: Playback
- ⑥ **▶▶▶**: Fast-Forward/Shuttle Search
- ⑦ **◀◀**: Rewind/Shuttle Search
- ⑧ **||**: Pause
- ⑨ **||▶**: Forward Frame-By-Frame Playback/Slow-Motion
- ⑩ **◀||**: Reverse Frame-By-Frame Playback/Slow-Motion
- ⑪ **⊕**: Audio Dubbing
- ⑫ **⊕||**: Audio Dubbing Pause (Appear while a tape is running.)
- ⑬ Sound Input For Audio Dubbing (☞ pg. 55)
- ⑭ Battery Remaining Power Indicator (☞ pg. 59)
- ⑮ Date/Time (☞ pg. 40, 42)
- ⑯ **VOLUME**: Volume Level Indicator (☞ pg. 22)
- ⑰ **BRIGHT**: Brightness Control Indicator (LCD monitor/Viewfinder) (☞ pg. 17)
- ⑱ Time Code (☞ pg. 40, 42)
- ⑲ **L** **R**: Auxiliary Microphone Level Indicator (Appears when an optional microphone is connected during Audio Dubbing. ☞ pg. 55)

\* GR-DF570/470 only

## During D.S.C. Playback (GR-DF570/470 only)

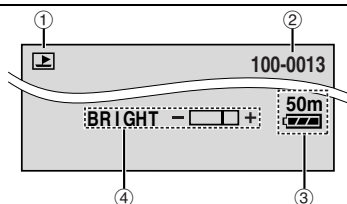

- ① Operation Mode Indicator (⇨ pg. 31)
- ② Folder/File Number (⇨ pg. 31)
- ③ Battery Remaining Power Indicator (⇨ pg. 59)
- ④ Brightness Control Indicator (LCD monitor/Viewfinder) (⇨ pg. 17)

## Before Using This Camcorder

**Make sure you only use cassettes with the Mini DV mark .**

**Make sure you only use memory cards\* with the mark  or MultiMediaCard.**

This camcorder is designed exclusively for the digital video cassette, SD Memory Card and MultiMediaCard. Only cassettes marked "Mini DV" and memory cards marked " or "MultiMediaCard" can be used with this unit.

\* Memory cards can be used with GR-DF570 and GR-DF470 only.

**Remember that this camcorder is not compatible with other digital video formats.**

**Remember that this camcorder is intended for private consumer use only.**

Any commercial use without proper permission is prohibited. (Even if you record an event such as a show, performance or exhibition for personal enjoyment, it is strongly recommended that you obtain permission beforehand.)

**Before recording important video, be sure to make a trial recording.**

Play back your trial recording to make sure the video and audio have been recorded properly.

**We recommend cleaning your video heads before use.**

If you haven't used your camcorder for a while, the heads may be dirty. We recommend periodically cleaning the video heads with a cleaning cassette (optional).

**Be sure to store your cassette tapes and camcorder in the proper environment.**

Video heads can become dirty more easily if your cassette tapes and camcorder are stored in a dusty area. Cassette tapes should be removed from the camcorder and stored in cassette cases. Store the camcorder in a bag or other container.

**Use SP (Standard) mode for important video recordings.**

LP (Long Play) mode lets you record 50% more video than SP (Standard) mode, but you may experience mosaic-like noise during playback depending on the tape characteristics and the usage environment.

So, for important recordings, we recommend using SP mode.

**It is recommended that you use JVC brand cassette tapes.**

Your camcorder is compatible with all brands of commercially available cassette tapes complying with the MiniDV standard, but JVC brand cassette tapes are designed and optimized to maximize the performance of your camcorder.

Also ⇨ "CAUTIONS" on pages 62 – 64.

- Microsoft® and Windows® are either registered trademarks or trademarks of Microsoft Corporation in the United States and/or other countries.
- Macintosh is a registered trademark of Apple Computer, Inc.
- QuickTime is a registered trademark of Apple Computer, Inc.

## Provided Accessories

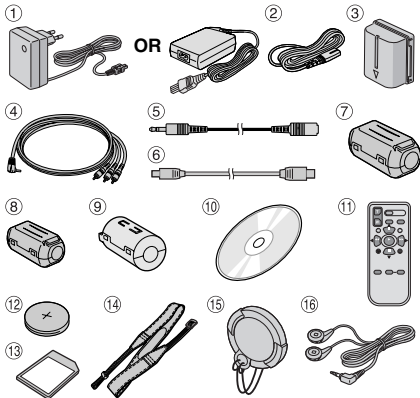

- ① AC Adapter AP-V17E or AP-V14E/A
- ② Power Cord (only for AP-V14E/A)
- ③ Battery Pack BN-VF707U
- ④ AV Cable
- ⑤ Audio Extension Cable  
(for optional microphone, pg. 12 for connection)
- ⑥ USB Cable\*
- ⑦ Core Filter [large]\*  
(for USB cable pg. 13 for attachment)
- ⑧ Core Filter [small] x 3 (GR-DF570 only)/  
x 2 (GR-DF470/430 only)  
(for Audio extension cable and AC Adapter's cable\*\* pg. 13 for attachment)
- ⑨ Core Filter  
(for AV cable pg. 13 for attachment)
- ⑩ CD-ROM\*
- ⑪ Remote Control Unit RM-V720U
- ⑫ Lithium Battery CR2025\*\*\*  
(for remote control unit)
- ⑬ Memory Card 8 MB\*  
(Already inserted in the camcorder)
- ⑭ Shoulder Strap ( pg. 12 for attachment)
- ⑮ Lens Cap (see the right column for attachment)
- ⑯ Mic for Biphonic\*

\* GR-DF570/470 only

\*\* GR-DF570 only

\*\*\*A lithium battery is pre-installed in the Remote Control Unit at time of shipment (with insulation sheet). To use the Remote Control Unit, remove the insulation sheet.

## NOTES:

- In order to maintain optimum performance of the camcorder, provided cables may be equipped with one or more core filter. If a cable has only one core filter, the end that is closest to the filter should be connected to the camcorder.
- Make sure to use the provided cables for connections. Do not use any other cables.

## How To Attach The Lens Cap

To protect the lens, attach the provided lens cap to the camcorder as shown in the illustration.

### NOTE:

To confirm the lens cap is on correctly make sure the cap is flush to the camcorder.

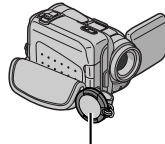

Place here during shooting.

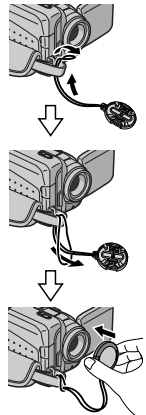

## How To Attach The Shoulder Strap

Follow the illustration.

- 1** Thread the strap through the eyelet.
- 2** Fold it back and thread it through the strap guide and the buckle.
  - To adjust the length of the strap, loosen and then tighten the strap in the buckle.
- 3** Slide the strap guide fully towards the eyelet.

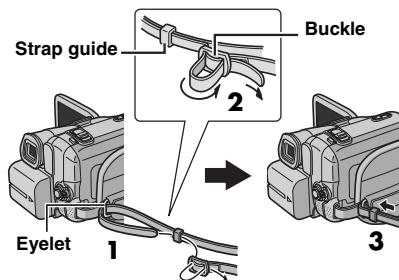

## How To Use The Audio Extension Cable

When using an optional external microphone, connect to the provided Audio extension cable (with a core filter attached), then connect the Audio extension cable to the camcorder. The core filter reduces interference. (▶ pg. 13)

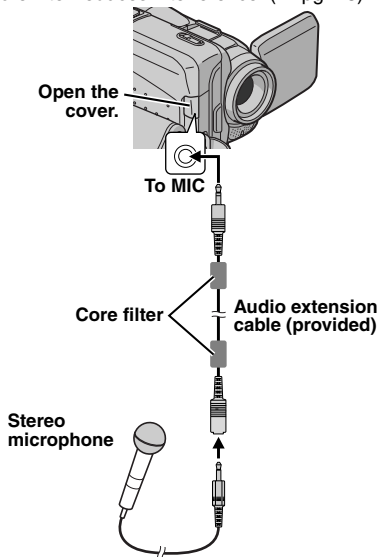

## How To Attach The Core Filter

Attach the core filters to the cables. The core filter reduces interference.

**1** Release the stoppers on both ends of the core filter.

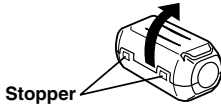

**2** Run the cable through the core filter, leaving approx. 3 cm of cable between the cable plug and the core filter.

Wind the cable once around the outside of the core filter as shown in the illustration.

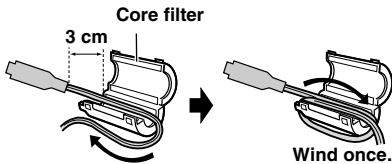

**3** Close the core filter until it clicks shut.

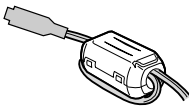

### NOTES:

- Take care not to damage the cable.
- When connecting a cable, attach the end with the core filter to the camcorder.

## Power

This camcorder's 2-way power supply system lets you choose the most appropriate source of power. Do not use provided power supply units with other equipment.

### Charging The Battery Pack

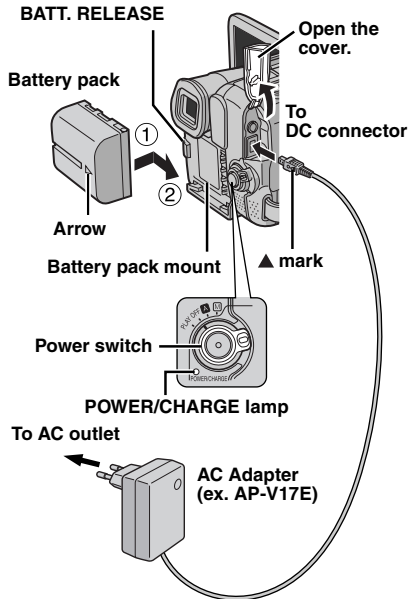

**1** Set the Power Switch to "OFF".

**2** With the arrow on the battery pack pointing right, push the battery pack slightly against the battery pack mount ①.

**3** Slide the battery pack to the right until it locks in place ②.

**4** Connect the AC Adapter to the camcorder.

**5** Connect the Power Cord to the AC Adapter. (AP-V14E/A only)

**6** Plug the AC Adapter into an AC outlet. The POWER/CHARGE lamp on the camcorder blinks to indicate charging has started.

**7** When the POWER/CHARGE lamp goes out, charging is finished. Unplug the AC Adapter from the AC outlet. Disconnect the AC Adapter from the camcorder.

**To detach the battery pack**

Slide the battery pack to the left while pressing **BATT. RELEASE** to detach it.

Battery pack	Charging time
BN-VF707U*	Approx. 1 hr. 30 min.
BN-VF714U	Approx. 2 hr. 40 min.
BN-VF733U	Approx. 5 hr. 40 min.

\* Provided

**NOTES:**

- **This product includes patented and other proprietary technology and will operate only with JVC Data Battery. Use the JVC BN-VF707U/VF714U/VF733U battery packs. Using generic non-JVC batteries can cause damage to the internal charging circuitry.**
- If the protective cap is attached to the battery pack, remove it first.
- During charging, the camcorder cannot be operated.
- Charging is not possible if the wrong type of battery is used.
- When charging the battery pack for the first time or after a long storage period, the POWER/CHARGE lamp may not light. In this case, remove the battery pack from the camcorder, then try charging again.
- If the battery operation time remains extremely short even after having been fully charged, the battery is worn out and needs to be replaced. Please purchase a new one.
- Since the AC Adapter processes electricity internally, it becomes warm during use. Be sure to use it only in well-ventilated areas.
- Using the optional AA-VF7 Battery Charger, you can charge the BN-VF707U/VF714U/VF733U battery pack without the camcorder.
- After 5 minutes has elapsed in Record-Standby mode with the cassette inserted, the camcorder will automatically turn off its power supplied from the AC adapter. In this case, the battery charge starts if the battery is attached to the camcorder.

**Using The Battery Pack**

Perform steps **2 – 3** in “Charging The Battery Pack”.

**Maximum continuous recording time**

Battery pack	LCD monitor on	Viewfinder on
BN-VF707U*	1 hr. 5 min. (1 hr.**)	1 hr. 25 min. (1 hr. 15 min.**)
BN-VF714U	2 hr. 20 min. (2 hr. 5 min.**)	3 hr. (2 hr. 35 min.**)
BN-VF733U	5 hr. 25 min. (4 hr. 50 min.**)	7 hr. 5 min. (6 hr. 5 min.**)

\* Provided

\*\* GR-DF570 only

**NOTES:**

- Recording time is reduced significantly under the following conditions:
  - Zoom or Record-Standby mode is engaged repeatedly.
  - The LCD monitor is used repeatedly.
  - The playback mode is engaged repeatedly.
  - The LED Light is used.
- Before extended use, it is recommended that you prepare enough battery packs to cover 3 times the planned shooting time.

**ATTENTION:**

Before detaching the power source, make sure that the camcorder's power is turned off. Failure to do so can result in a camcorder malfunction.

**Data Battery System**

You can check the remaining battery power and the recordable time.

- 1) Make sure the battery is attached and the Power Switch is set to “OFF”.
- 2) Open the LCD monitor fully.
- 3) Press **BATT. DATA**, and the battery status screen appears.
  - It can be displayed on the viewfinder when the LCD monitor is closed.
  - It is displayed for 5 seconds if the button is pressed and released quickly, and for 15 seconds if the button is pressed and hold for several seconds.
  - If “COMMUNICATION ERROR” appears instead of the battery status even though you tried to press **BATT. DATA** several times, there may be a problem on the battery. In such a case, consult your nearest JVC dealer.

## Using AC Power

Perform steps **4** – **5** in “Charging The Battery Pack”.

### NOTE:

The provided AC Adapter features automatic voltage selection in the AC range from 110 V to 240 V.

## About Batteries

**DANGER!** Do not attempt to take the batteries apart, or expose them to flame or excessive heat, as it may cause a fire or explosion.

**WARNING!** Do not allow the battery or its terminals to come in contact with metals, as this can result in a short circuit and possibly start a fire.

### To resume the original function of the accurate battery power indication

If the battery power indication differs from the actual operating time, fully charge the battery, and then run it down. However this function may not turn back if the battery was used for a long period of time under extremely high/low temperature condition or charged too many times.

## Operation Mode

To turn on the camcorder, set the Power Switch to any operation mode except “OFF” while pressing down the Lock Button located on the switch.

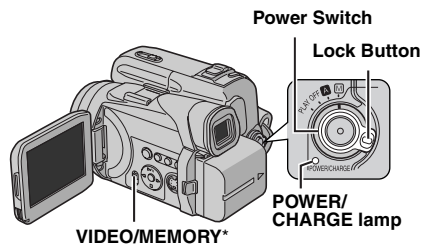

Choose the appropriate operation mode according to your preference using the Power Switch and **VIDEO/MEMORY** Switch.\*

\* GR-DF570/470 only

### Power Switch Position

#### **A** (Full Auto Recording):

Allows you to record using NO special effects or manual adjustments. Suitable for standard recording.

The “**A**” indicator appears on the display.

#### **M** (Manual Recording):

Allows you to set various recording functions using the Menus. (☞ pg. 37)

If you want more creative capabilities than Full Auto Recording, try this mode.

#### **OFF:**

Allows you to switch off the camcorder.

#### **PLAY:**

- Allows you to play back a recording on the tape.
- Allows you to display a still image stored in the memory card or to transfer a still image stored in the memory card to a PC. (GR-DF570/470 only)
- Allows you to set various playback functions using the Menus. (☞ pg. 37)

### VIDEO/MEMORY Switch Position (GR-DF570/470 only)

#### **VIDEO:**

Allows you to record on a tape or play back a tape. If “REC SELECT” is set to “▶ **V** ▶ **M**” (☞ pg. 41), still images are recorded both on the tape and the memory card.

#### **MEMORY:**

- Allows you to record in a memory card or access data stored in a memory card.
- When the Power Switch is set to “**A**” or “**M**”, the currently selected image size appears.

## Power-Linked Operation

When the Power Switch is set to “**A**” or “**M**”, you can also turn on/off the camcorder by opening/closing the LCD monitor or pulling out/pushing in the viewfinder.

### INFORMATION:

The following explanations in this manual suppose the use of LCD monitor in your operation. If you want to use the viewfinder, close the LCD monitor and pull out the viewfinder fully.

## Language Settings

The language on the display can be changed. (⇨ pg. 37, 40, 42)

**1** Set the Power Switch to “**M**” while pressing down the Lock Button located on the switch.

**2** Open the LCD monitor fully. (⇨ pg. 19)

**3** Press **MENU**. The Menu Screen appears.

**4** Press  $\blacktriangle$  or  $\blacktriangledown$  to select “**CAMERA DISPLAY**”, and press **SET**. The CAMERA DISPLAY Menu appears.

**5** Press  $\blacktriangle$  or  $\blacktriangledown$  to select “**LANGUAGE**”, and press **SET**.

**6** Press  $\blacktriangle$  or  $\blacktriangledown$  to select the desired language, and press **SET**.

**7** Press  $\blacktriangle$  or  $\blacktriangledown$  to select “**URETURN**”, and press **SET** twice. The Menu Screen closes.

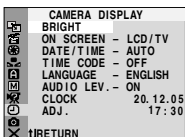

ex. for GR-DF570/  
470

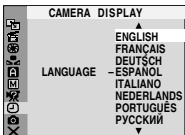

## Date/Time Settings

The date/time is recorded onto the tape at all times, but its display can be turned on or off during playback. (⇨ pg. 37, 42)

**1** Perform steps **1 – 4** in “Language Settings” above.

**2** Press  $\blacktriangle$  or  $\blacktriangledown$  to select “**CLOCK ADJ.**”, and press **SET**. The parameter for “Day” is highlighted.

**3** Press  $\blacktriangle$  or  $\blacktriangledown$  to input the day, and press **SET**. Repeat to input the month, year, hour and minute.

**4** Press  $\blacktriangle$  or  $\blacktriangledown$  to select “**URETURN**”, and press **SET** twice. The Menu Screen closes.

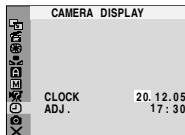

## Grip Adjustment

**1** Adjust the velcro strip.

**2** Pass your right hand through the loop and grasp the grip.

**3** Adjust your thumb and fingers through the grip to easily operate the Recording Start/Stop Button, Power Switch and Power Zoom Lever. Be sure to fasten the velcro strip to your preference.

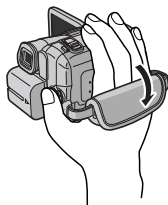

## Viewfinder Adjustment

**1** Set the Power Switch to “**A**” or “**M**” while pressing down the Lock Button located on the switch.

**2** Make sure the LCD monitor is closed and locked. Pull out the viewfinder fully and adjust it manually for best viewability.

**3** Turn the Dioptre Adjustment Control until the indications in the viewfinder are clearly focused.

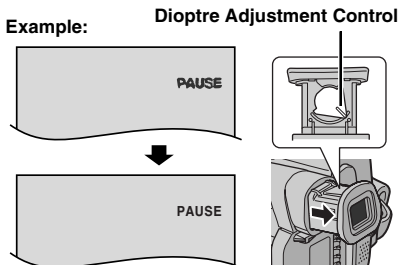

### CAUTION:

When retracting the viewfinder, take care not to pinch your fingers.



## Brightness Adjustment Of The Display

**1** Set the Power Switch to "CAM" or "PLAY" while pressing down the Lock Button located on the switch.

**2** Open the LCD monitor fully. (pg. 19)

- To adjust the brightness of the viewfinder, pull out the viewfinder fully and set "PRIORITY" to "FINDER" (pg. 37, 40).

**3** Press **MENU**. The Menu Screen appears.

**4** Press  $\wedge$  or  $\vee$  to select "CAM", and press **SET**. The CAMERA DISPLAY Menu appears.

**5** Press  $\wedge$  or  $\vee$  to select "BRIGHT", and press **SET**. The Menu Screen closes and the brightness control indicator appears.

**6** Press  $<$  or  $>$  until the appropriate brightness is reached.

**7** Press **MENU** to clear the brightness control indicator from the display.

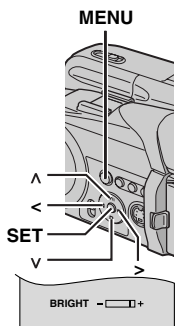

## Loading/Unloading A Cassette

The camcorder needs to be powered up to load or eject a cassette.

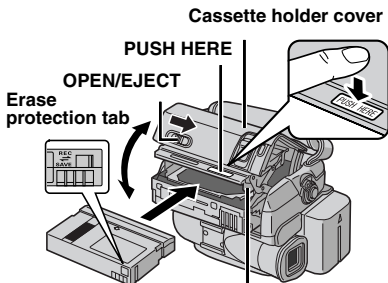

Make sure the window side is facing out.

**1** Slide and hold **OPEN/EJECT** in the direction of the arrow, then pull the cassette holder cover open until it locks. The cassette holder opens automatically.

- Do not touch internal components.

**2** Insert or remove a tape and press "PUSH HERE" to close the cassette holder.

- Be sure to press only the section labelled "PUSH HERE" to close the cassette holder; touching other parts may cause your finger to get caught in the cassette holder, resulting in injury or product damage.

- Once the cassette holder is closed, it recedes automatically. Wait until it recedes completely before closing the cassette holder cover.
- When the battery pack's charge is low, you may not be able to close the cassette holder cover. Do not apply force. Replace the battery pack with a fully charged one or use AC power before continuing.

**3** Close the cassette holder cover firmly until it locks into place.

### To protect valuable recordings

Slide the erase protection tab on the back of the tape in the direction of "SAVE". This prevents the tape from being recorded over. To record on this tape, slide the tab back to "REC" before loading it.

## Tripod Mounting

To attach the camcorder to a tripod, align the direction stud and screw to the mounting socket and stud hole on the camcorder. Then tighten the screw clockwise.

- Some tripods are not equipped with studs.

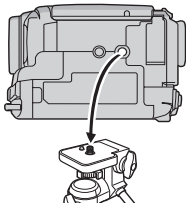

**NOTES:**

- If you wait a few seconds and the cassette holder does not open, close the cassette holder cover and try again. If the cassette holder still does not open, turn the camcorder off then on again.
- If the tape does not load properly, open the cassette holder cover fully and remove the cassette. A few minutes later, insert it again.
- When the camcorder is suddenly moved from a cold place to a warm environment, wait a short time before opening the cassette holder cover.

**NOTES:**

- Some brands of memory cards are not compatible with this camcorder. Before purchasing a memory card, consult its manufacturer or dealer.
- Before using a new memory card, it is necessary to format the card. (▶ pg. 36)

**ATTENTION:**

Do not insert or remove the memory card while the camcorder is turned on, as this may cause the memory card to be corrupted or cause the camcorder to become unable to recognise whether or not the card is installed.

## Loading/Unloading A Memory Card (GR-DF570/470 only)

The provided memory card is already inserted in the camcorder at the time of purchase.

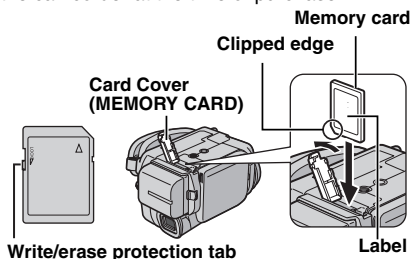

- 1** Make sure the camcorder's power is off.
- 2** Open the card cover (MEMORY CARD).
- 3** **To load a memory card**, firmly insert it with its clipped edge first.  
**To unload a memory card**, push it once. After the memory card comes out of the camcorder, pull it out.
  - Do not touch the terminal on the reverse side of the label.
- 4** Close the card cover.

### To protect valuable files (available only for SD Memory Card)

Slide the write/erase protection tab on the side of the memory card in the direction of "LOCK". This prevents the memory card from being recorded over. To record on this memory card, slide the tab back to the position opposite to "LOCK" before loading it.

## Basic Recording

### NOTE:

Before continuing, perform the procedures listed below:

- Power (⇨ pg. 13)
- Loading A Cassette (⇨ pg. 17)

### VIDEO/MEMORY\*

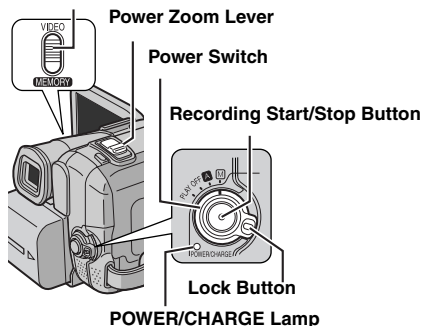

- 1 Remove the lens cap. (⇨ pg. 11)
- 2 Open the LCD monitor fully.
- 3 Set the VIDEO/MEMORY Switch to "VIDEO".\*
- 4 Set the Power Switch to "A" or "M" while pressing down the Lock Button located on the switch.

- The POWER/CHARGE lamp lights and the camcorder enters the Record-Standby mode. "PAUSE" is displayed.
- To record in LP (Long Play) mode, ⇨ pg. 38.

5 To start recording, press the Recording Start/Stop Button. "REC" appears on the display while recording is in progress.

6 To stop recording, press the Recording Start/Stop Button again. The camcorder re-enters the Record-Standby mode.

\* GR-DF570/470 only

### Approximate recording time

Tape	Recording mode	
	SP	LP
30 min.	30 min.	45 min.
60 min.	60 min.	90 min.
80 min.	80 min.	120 min.

### NOTES:

- If the Record-Standby mode continues for 5 minutes, the camcorder's power shuts off automatically. To turn the camcorder on again, push back and pull out the viewfinder again or close and re-open the LCD monitor.
- When a blank portion is left between recorded scenes on the tape, the time code is interrupted and errors may occur when editing the tape. To avoid this, refer to "Recording From The Middle Of A Tape" (⇨ pg. 21).
- To turn the beep sounds off, ⇨ pg. 37, 39.

### Tape Remaining Time

Approximate tape remaining time appears on the display.

"- h - - m" means the camcorder is calculating the remaining time. When the remaining time reaches 2 minutes, the indication starts blinking.

- The time required to calculate and display the remaining tape length, and the accuracy of the calculation, may vary according to the type of tape used.

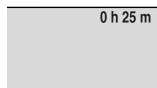

### LCD Monitor And Viewfinder

#### While using the LCD monitor:

Make sure the viewfinder is pushed back in. Pull on the end (A) of the LCD monitor and open the LCD monitor fully. It can rotate 270° (90° downward, 180° upward).

#### While using the viewfinder:

Make sure the LCD monitor is closed and locked. Pull out the viewfinder fully.

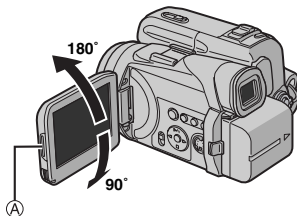

**NOTES:**

- The image will not appear simultaneously on the LCD monitor and the viewfinder. When the viewfinder is pulled out while the LCD monitor is opened, you can select which one to use. Set "PRIORITY" to the desired mode in SYSTEM Menu. (⇨ pg. 37, 40)
- Coloured bright spots may appear all over the LCD monitor or the viewfinder. However, this is not a malfunction. (⇨ pg. 58)

**Zooming**

Produces the zoom in/out effect, or an instantaneous change in image magnification.

**Zoom In**

Slide the Power Zoom Lever towards "T".

**Zoom Out**

Slide the Power Zoom Lever towards "W".

- The further you slide the Power Zoom Lever, the quicker the zoom action.

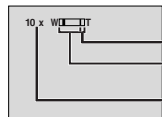
**Zoom in (T: Telephoto)****Zoom out (W: Wide angle)**

- Digital zoom zone
- 15X (optical) zoom zone
- Approximate zoom ratio

**NOTES:**

- Focusing may become unstable during Zooming. In this case, set the zoom while in Record-Standby, lock the focus by using the manual focus (⇨ pg. 45), then zoom in or out in Record mode.
- Zooming is possible to a maximum of 700X, or it can be switched to 15X magnification using the optical zoom. (⇨ pg. 38)
- Zoom magnification of over 15X is done through Digital image processing, and is therefore called Digital Zoom.
- During Digital zoom, the quality of image may suffer.
- Digital zoom cannot be used when the VIDEO/MEMORY Switch is set to "MEMORY". (GR-DF570/470 only)

- Macro shooting (as close as approx. 5 cm to the subject) is possible when the Power Zoom Lever is set all the way to "W". Also see "TELE MACRO" in MANUAL Menu on page 39.
- When shooting a subject close to the lens, zoom out first. If zoomed-in in the auto focus mode, the camcorder may automatically zoom out depending on the distance between the camcorder and the subject. This will not occur when "TELE MACRO" is set to "ON". (⇨ pg. 39)

**Journalistic Shooting**

In some situations, different shooting angles may provide more dramatic results. Hold the camcorder in the desired position and tilt the LCD monitor in the most convenient direction. It can rotate 270° (90° downward, 180° upward).

**Self Recording**

Open the LCD monitor and tilt it upward to 180° so that it faces forward, point the lens toward yourself and start recording.

**Self Recording**

## Time Code

During recording, a time code is recorded on the tape. This code is to confirm the location of the recorded scene on the tape during playback.

### Display

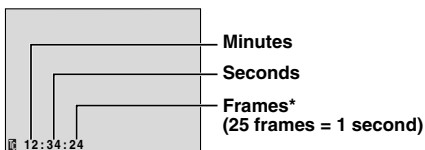

\* Frames are not displayed during recording.

If recording starts from a blank portion, the time code begins counting from "00:00:00" (minute:second:frame). If recording starts from the end of a previously recorded scene, the time code continues from the last time code number. If during recording a blank portion is left partway through the tape, the time code is interrupted. When recording is resumed, the time code starts counting up again from "00:00:00". This means the camcorder may record the same time codes as those existing in a previously recorded scene. To prevent this, perform Recording From The Middle Of A Tape (See the right column.) in the following cases;

- When shooting again after playing back a recorded tape.
- When power shuts off during shooting.
- When a tape is removed and re-inserted during shooting.
- When shooting using a partially recorded tape.
- When shooting on a blank portion located partway through the tape.
- When shooting again after shooting a scene then opening/closing the cassette holder cover.

### NOTES:

- The time code cannot be reset.
- During fast-forwarding and rewinding, the time code indication does not move smoothly.
- The time code is displayed only when "TIME CODE" is set to "ON". (ⓘ pg. 40)

## Quick Review

Enables to check the end of the last recording.

- 1) Press **Q.REVIEW** during the Recording-Standby mode.
- 2) Tape is rewound for about several seconds and played back automatically, then pauses in the Recording-Standby mode for the next shot.
  - Distortion may occur at start of playback. This is normal.

## Recording From The Middle Of A Tape

- 1) Play back a tape or use Blank Search (ⓘ pg. 22) to find the spot at which you want to start recording, then engage the Still Playback mode. (ⓘ pg. 22)
- 2) Set the Power Switch to "A" or "M" while pressing down the Lock Button located on the switch, then start recording.

## Normal Playback

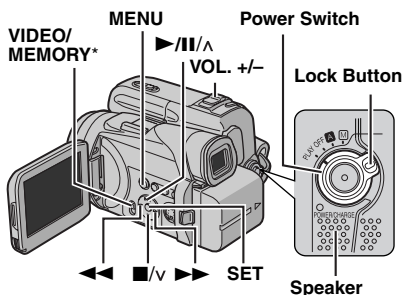

- 1 Load a cassette. (☞ pg. 17)
  - 2 Set the **VIDEO/MEMORY** Switch to "VIDEO".\*
  - 3 Set the Power Switch to "PLAY" while pressing down the Lock Button located on the switch.
  - 4 To start playback, press ►/II.
  - 5 To stop playback, press ■.
- During Stop mode, press ◀◀ to rewind, or ▶▶ to fast-forward the tape.
  - \* GR-DF570/470 only

### To control the speaker volume

Slide the Power Zoom Lever (VOL. +/-) towards "+" to turn up the volume, or towards "-" to turn down the volume.

### NOTES:

- The playback picture can be viewed in the LCD monitor, viewfinder or on a connected TV. (☞ pg. 23)
- If Stop mode continues for 5 minutes when power is supplied from a battery, the camcorder shuts off automatically. To turn on again, set the Power Switch to "OFF", then to "PLAY".
- When a cable is connected to the AV connector, the sound is not heard from the speaker.

## Still Playback

Pauses during video playback.

- 1) Press ►/II during playback.
  - 2) To resume normal playback, press ►/II again.
- If still playback continues for more than about 3 minutes, the camcorder's Stop mode is automatically engaged.

## Shuttle Search

Allows high-speed search in either direction during video playback.

- 1) During playback, press ►► for forward search, or ◀◀ for reverse search.
  - 2) To resume normal playback, press ►/II.
- During playback, press and hold ►► or ◀◀. The search continues as long as you hold the button. Once you release the button, normal playback resumes.
  - A slight mosaic effect appears on the display during Shuttle Search. This is not a malfunction.

### ATTENTION:

During Shuttle Search, parts of the picture may not be clearly visible, particularly on the left side of the screen.



## Blank Search

Helps you find where you should start recording in the middle of a tape to avoid time code interruption. (☞ pg. 21)

- 1 Load a cassette. (☞ pg. 17)
  - 2 Set the **VIDEO/MEMORY** Switch to "VIDEO".\*
  - 3 Set the Power Switch to "PLAY" while pressing down the Lock Button located on the switch.
  - 4 Press **MENU**. The Menu Screen appears.
  - 5 Press **MENU** to select "BL". The VIDEO Menu appears.
  - 6 Press ▲ or ▼ to select "BLANK SRCH", and press **SET**. The Sub Menu appears.
  - 7 Press ▲ or ▼ to select "EXECUTE", and press **SET**.
- The "BLANK SEARCH" indication appears and the camcorder automatically starts reverse or forward search, then stops at the spot which is about 3 seconds of tape before the beginning of the detected blank portion.
  - To cancel Blank Search midway, press ■.
  - \* GR-DF570/470 only

**NOTES:**

- Before starting Blank Search, if the current position is at a blank portion, the camcorder searches in the reverse direction. If the current position is at a recorded portion, the camcorder searches in the forward direction.
- If the beginning or end of the tape is reached during Blank Search, the camcorder stops automatically.
- A blank portion which is shorter than 5 seconds of tape may not be detected.
- The detected blank portion may be located between recorded scenes. Before you start recording, make sure there is no recorded scene after the blank portion.

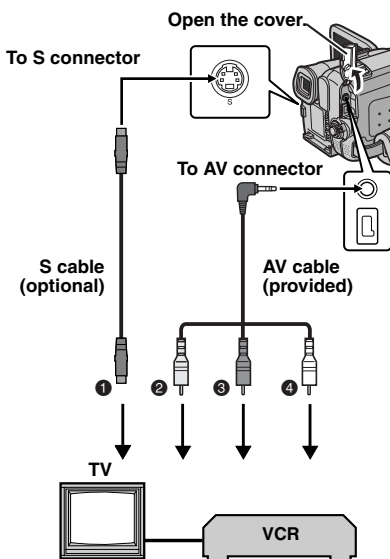
**Connections To A TV Or VCR**

- 1 Black to S-VIDEO IN (Connect when your TV/VCR has S-VIDEO IN and A/V input connectors. In this case, it is not necessary to connect the yellow video cable.)
  - 2 Yellow to VIDEO IN (Connect when your TV/VCR has only A/V input connectors.)
  - 3 Red to AUDIO R IN\*
  - 4 White to AUDIO L IN\*
- \* Not required for watching still images only.

**NOTE:**

The S-Video cable is optional. Be sure to use the YTU94146A S-Video cable. Consult the JVC Service Center described on the sheet included in the package for details on its availability. Make sure to connect the end with a core filter to the camcorder. The core filter reduces interference.

- 1 Make sure all units are turned off.
  - 2 Connect the camcorder to a TV or VCR as shown in the illustration.
- If using a VCR, go to step 3.  
If not, go to step 4.
- 3 Connect the VCR output to the TV input, referring to your VCR's instruction manual.
  - 4 Turn on the camcorder, the VCR and the TV.
  - 5 Set the VCR to its AUX input mode, and set the TV to its VIDEO mode.
  - 6 Start playback on the camcorder. (☞ pg. 22)

**To choose whether or not the following displays appear on the connected TV**

- Date/time
  - Set "DATE/TIME" to "AUTO", "ON" or "OFF". (☞ pg. 37, 42)
  - Or, press **DISPLAY** on the remote control to turn on/off the date indication.
- Time code
  - Set "TIME CODE" to "ON" or "OFF". (☞ pg. 37, 42)
- Indications other than date/time and time code
  - Set "ON SCREEN" to "OFF", "LCD" or "LCD/TV". (☞ pg. 37, 42)

**NOTES:**

- It is recommended to use the AC Adapter as the power supply instead of the battery pack. (☞ pg. 15)
- To monitor the picture and sound from the camcorder without inserting a tape or memory card\*, set the camcorder's Power Switch to "A" or "M", then set your TV to the appropriate input mode.
- \* GR-DF570/470 only
- Make sure you adjust the TV sound volume to its minimum level to avoid a sudden burst of sound when the camcorder is turned on.

## Biphonic Playback (GR-DF570/470 only)

You can reproduce real three-dimensional acoustic fields on a conventional TV, VCR, or stereo system connected to the camcorder.

**1** Shoot a video in Biphonic Recording mode. (☞ pg. 51)

**2** Connect the camcorder to a TV, VCR, or stereo system. (☞ pg. 23)

**3** Perform steps **1** – **3** in "Normal Playback" (☞ pg. 22).

**4** Press **BIPHONIC** to change the setting. "A" or "A\*": Biphonic mode is automatically engaged when the camcorder detects footage recorded with the Mic for Biphonic while "AUX MIC" is set to "BIPHONIC". "ON" or "ON\*": Biphonic mode is engaged.

No indication: Biphonic mode is disengaged.

\* "ON" appears when the camcorder detects footage recorded while "AUX MIC" is set to "OFF"

**NOTES:**

- As long as you use the Mic for Biphonic, even if "AUX MIC" is set to "OFF" on Biphonic Recording, you can obtain a Biphonic effect by selecting "ON" on the playback.
- Make sure that Biphonic mode is disengaged when you use headphones at Biphonic playback to obtain genuine Biphonic effect.
- When you use a microphone other than the Mic for Biphonic during Biphonic Recording, you cannot obtain an expected effect even if "ON" or "ON" is selected on the playback.

**5** To start playback, press ►/II.

**NOTES:**

- Stereo speakers (incorporated in a TV) are required for Biphonic playback.
- Biphonic effect is maximized in the following cases:
  - When you enjoy the video on a big screen TV.
  - When the distance between the left and right speakers is sufficient.
  - When you position at front center of both speakers.

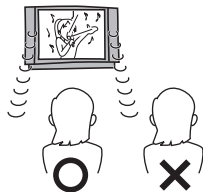



## Playback Using The Remote Control

The Full-Function Remote Control Unit can operate this camcorder from a distance as well as the basic operations (Playback, Stop, Pause, Fast-Forward and Rewind) of your VCR. It also makes additional playback functions possible. (⇨ pg. 26)

### Installing The Battery

The remote control uses one lithium battery (CR2025).

**1** Pull out the battery holder by pushing the lock tab.

**2** Insert the battery in the holder, and be sure to have the "+" mark visible.

**3** Slide the holder back in until you hear a click.

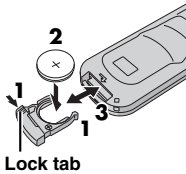

### Beam Effective Area (indoor use)

When using the remote control, be sure to point it at the remote sensor. The transmitted beam's approximate effective distance for indoor use is 5 m.

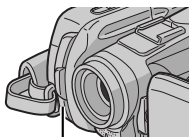

Remote sensor

#### NOTE:

The transmitted beam may not be effective or may cause incorrect operation when the remote sensor is directly exposed to sunlight or powerful lighting.

## Buttons And Functions

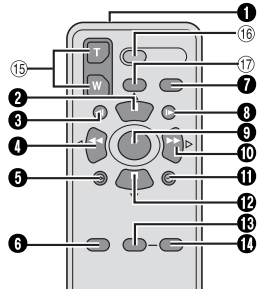

- 1** Infrared beam transmitting window  
 • Transmits the beam signal.

The following buttons are available only when the camcorder's Power Switch is set to "PLAY".

- 2** PAUSE Button  
 • Pauses the tape (⇨ pg. 26)  
 Up Button (⇨ pg. 27)
- 3** SLOW Rewind Button (⇨ pg. 26)
- 4** REW Button  
 • Rewind/Reverse Shuttle Search on a tape (⇨ pg. 22)  
 • Displays previous file in a memory card\* (⇨ pg. 30)  
 Left Button (⇨ pg. 27)
- 5** INSERT Button (⇨ pg. 56)
- 6** SHIFT Button (⇨ pg. 27)
- 7** DISPLAY Button (⇨ pg. 23, 52)
- 8** SLOW Forward Button (⇨ pg. 26)
- 9** PLAY Button  
 • Starts Playback of a tape (⇨ pg. 22)  
 • Starts Auto Playback of images in a memory card\* (⇨ pg. 30)
- 10** FF Button  
 • Forward/Forward Shuttle Search on a tape (⇨ pg. 22)  
 • Displays next file in a memory card\* (⇨ pg. 30)  
 Right Button (⇨ pg. 27)
- 11** A. DUB Button (⇨ pg. 55)
- 12** STOP Button  
 • Stops the tape (⇨ pg. 22)  
 • Stops Auto Playback\* (⇨ pg. 30)  
 Down Button (⇨ pg. 27)
- 13** EFFECT Button (⇨ pg. 27)
- 14** EFFECT ON/OFF Button (⇨ pg. 27)

The following buttons are available when the camcorder's Power Switch is set to "A" or "M".

15 Zoom (T/W) Buttons

Zoom in/out (→ pg. 20, 27)

(Also available with the Power Switch set to "PLAY")

16 START/STOP Button

Functions the same as the Recording Start/Stop Button on the camcorder.

17 S.SHOT Button

Functions the same as **SNAPSHOT** on the camcorder.

(Also available with the Power Switch set to "PLAY")

\* GR-DF570/470 only

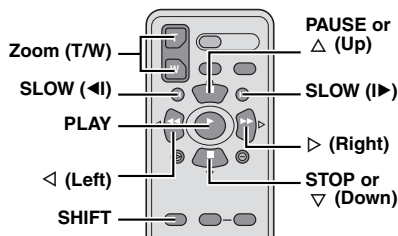

## Slow-Motion Playback

During normal video playback, press **SLOW** (◀| or |▶) more than approx. 2 seconds.

- After approx. 10 minutes, normal playback resumes.
- To pause Slow-Motion playback, press **PAUSE** (II).
- To stop Slow-Motion playback, press **PLAY** (▶).

### NOTES:

- You can also engage Slow-Motion Playback from Still Playback by pressing **SLOW** (◀| or |▶) more than approx. 2 seconds.
- During Slow-Motion Playback, due to digital image processing, the picture may take on a mosaic effect.
- After **SLOW** (◀| or |▶) is pressed and held, the still image may be displayed for a few seconds, followed by a blue screen for a few seconds. This is not a malfunction.
- During Slow-Motion Playback, there will be disturbances in video and the picture may seem unstable, especially with steady images. This is not a malfunction.

## Frame-By-Frame Playback

During normal or still playback, press **SLOW** (|▶) repeatedly for forward or **SLOW** (◀|) repeatedly for reverse. Each time **SLOW** (◀| or |▶) is pressed, the frame is played back.

## Playback Zoom

Magnifies the recorded image up to 47X at any time during video playback and D.S.C. playback (GR-DF570/470 only).

1) Press **PLAY** (▶) to start video playback. Or perform normal playback of images.



2) At the point you want to zoom in, press the Zoom Button (T).

• To zoom out, press the Zoom Button (W).



3) You can move the image on the screen around to find a particular portion of the picture. While holding down **SHIFT**, press ◀ (Left), ▶ (Right), ▲ (Up) and ▼ (Down).



• To end zoom, press and hold **W** until magnification returns to normal. Or, press **STOP** (■) and then press **PLAY** (▶) during video playback.

### NOTES:

- Zoom can also be used during slow-motion and still playback.
- Due to digital image processing, the quality of the image may suffer.

## Playback Special Effects

Allows you to add creative effects to the video playback image.

🎞️ **CLASSIC FILM:** Gives recorded scenes a strobe effect.

**B/W MONOTONE:** Like classic black and white films, your footage is shot in B/W. Used together with the Cinema mode, it enhances the “classic film” effect.

🖼️ **SEPIA:** Recorded scenes have a brownish tint like old photos. Combine this with the Cinema mode for a classic look.

📷 **STROBE:** Your recording looks like a series of consecutive snapshots.

1) To start playback, press **PLAY** (▶).

2) Press

**EFFECT**. The **PLAYBACK EFFECT** Select Menu appears.

3) Press **EFFECT** repeatedly to move the highlight bar to the desired effect.

- The selected function is activated and after 2 seconds the menu disappears.
- To deactivate the selected effect, press **EFFECT ON/OFF**. To reactivate the selected effect press **EFFECT ON/OFF** again.
- To change the selected effect, repeat from step 2 above.

**EFFECT ON/OFF**  
**EFFECT**

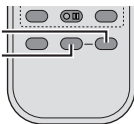

## Basic Shooting (D.S.C. Snapshot)

You can use your camcorder as a Digital Still Camera for taking snapshots. Still images are stored in the memory card.

### NOTE:

Before continuing, perform the procedures listed below:

- Power (⇨ pg. 13)
- Loading a Memory Card (⇨ pg. 18)

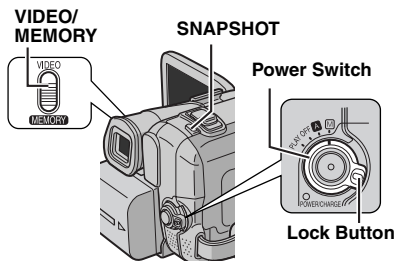

- 1 Remove the lens cap.
- 2 Open the LCD monitor fully. (⇨ pg. 19)
- 3 Set the **VIDEO/MEMORY** Switch to "MEMORY".
- 4 Set the Power Switch to "A" or "M" while pressing down the Lock Button located on the switch.
  - To change the Image Size and/or Picture Quality, ⇨ pg. 37, 41.
- 5 Press **SNAPSHOT**. The "PHOTO" indication appears while the snapshot is being taken.
  - To check how the image looks before recording it in the memory card, press **SNAPSHOT** halfway and hold. The "A" indicator appears and stops blinking when the captured image is focused. To cancel the recording, release **SNAPSHOT**. To record it in the memory card, press **SNAPSHOT** fully.
  - Still images are recorded in the snapshot mode with no frame.
  - To delete unwanted still images, refer to "Deleting Files" (⇨ pg. 34).
  - When you do not want to hear the shutter sound, set "BEEP" to "OFF". (⇨ pg. 37, 39)

### NOTE:

If shooting is not performed for approx. 5 minutes when the Power Switch is set to "A" or "M" and power is supplied from the battery pack, the camcorder shuts off automatically to save power. To perform shooting again, push back and pull out the viewfinder again or close and re-open the LCD monitor.

### Approximate Number of Storable Images

- The number increases or decreases depending on the Picture Quality/Image Size, etc.

Image Size/Picture Quality	SD Memory Card			
	8 MB*	16 MB	32 MB	64 MB
640 x 480/FINE	47	95	205	425
640 x 480/STANDARD	160	295	625	1285
1024 x 768/FINE	21	47	95	200
1024 x 768/STANDARD	65	145	310	640
1152 x 864/FINE***	13	29	60	125
1152 x 864/STANDARD***	45	95	205	425
1600 x 1200/FINE***	8	19	41	80
1600 x 1200/STANDARD***	28	60	130	275

Image Size/Picture Quality	MultiMediaCard		
	8 MB**	16 MB	32 MB
640 x 480/FINE	55	105	215
640 x 480/STANDARD	190	320	645
1024 x 768/FINE	25	50	100
1024 x 768/STANDARD	75	160	320
1152 x 864/FINE***	16	32	60
1152 x 864/STANDARD***	50	105	216
1600 x 1200/FINE***	10	21	42
1600 x 1200/STANDARD***	34	65	135

\* Provided (GR-DF570 only)

\*\* Provided (GR-DF470 only)

\*\*\* GR-DF570 only

## Interval Shooting

During Interval Shooting mode, the camcorder continues to take snapshots automatically with an interval of your desired setting.

- 1** Set "INT.SHOT" to "ON". (⇨ pg. 37, 41)
  - "INTERVAL" and "⌚" appear.
- 2** Set "INT.TIME" to the desired shooting interval. (⇨ pg. 37, 41)
- 3** Set the Power Switch to "A" or "M" while pressing down the Lock Button located on the switch.
- 4** Press **SNAPSHOT**.
  - First shot is taken after 2 seconds.
  - The "PHOTO" indicator appears while the snapshot is being taken.
  - The clock icon "⌚" turns while waiting for the next shot is being taken.
  - The next shot is being taken automatically when the shooting interval set in step **2** has passed.
- 5** Press **SNAPSHOT** to stop Interval Shooting.

### To cancel Interval Shooting mode

Set "INT.SHOT" to "OFF" in step **1**.

### NOTES:

- To distinguish between still images taken in Interval Shooting mode and other still images, it is recommended that you reset the file names before shooting. (⇨ pg. 33)
- Interval Shooting will stop if the battery runs out of power or the Memory Card becomes full.
- The function "Animation" in the provided software "Digital Photo Navigator" can be used to create movie files from the captured still images (Windows® only). To create movie files with the Macintosh, it is recommended that you use the function "Creating a Slideshow From Still Images" in the commercial software "QuickTime Pro".

## Normal Playback Of Images

Images shot with the camcorder are automatically numbered, then stored in numerical order in the memory card. You can view the stored images, one at a time, much like flipping through a photo album.

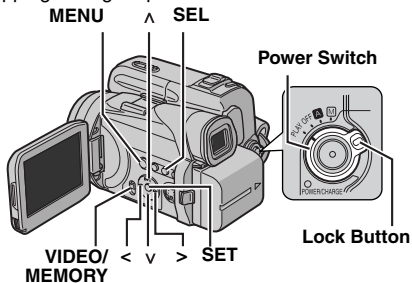

- 1 Load a memory card. ( pg. 18)
- 2 Set the **VIDEO/MEMORY** Switch to "MEMORY".
- 3 Set the Power Switch to "PLAY" while pressing down the Lock Button located on the switch.
  - The type of file (IMAGE or E-MAIL CLIP) which has been played back at the last time is displayed.
- 4 If the video clip playback (E-MAIL CLIP, see the right column) screen appears, press **SEL**. The MEMORY SELECT screen appears.
- 5 Press  $\wedge$  or  $\vee$  to select "IMAGE", and press **SET**. The image playback screen (IMAGE) appears.
- 6 Press  $<$  to display the previous file. Press  $>$  to display the next file.

### NOTE:

Images shot and stored on the card with another device with resolutions other than "640 x 480" and "1024 x 768" will be displayed as thumbnails only. These thumbnail images cannot be transferred to a PC.

## Playback Zoom

Available only with the remote control.

( pg. 26)

## Auto Playback Of Images

You can run through all the images stored in memory card automatically.

- 1 Perform steps **1 – 3** in "Normal Playback Of Images".
- 2 Press  $\blacktriangleright$ /II to start Auto Playback.
  - If you press  $<$  during Auto Playback, files are displayed in descending order.
  - If you press  $>$  during Auto Playback, files are displayed in ascending order.
- 3 To end Auto Playback, press  $\blacksquare$ .

## Playback Of Video Clips

You can view video clips ( pg. 32) stored in the memory card.

- 1 Perform steps **1 – 3** in "Normal Playback Of Images".
- 2 If the image playback (IMAGE) screen appears, press **SEL**. The MEMORY SELECT screen appears.
- 3 Press  $\wedge$  or  $\vee$  to select "E-MAIL CLIP", and press **SET**. The video clip playback screen (E-MAIL CLIP) appears.
- 4 Press  $<$  to select the previous file. Press  $>$  to select the next file.
- 5 To start playback, press  $\blacktriangleright$ /II.
- 6 To stop playback, press  $\blacksquare$ .



### NOTES:

- The video clip files stored with this camcorder are compatible with MPEG4. Some MPEG4 files stored with other devices cannot be played back with this camcorder.
- You can also view video clips on your PC by using Windows® Media Player version 6.4 or later. Refer to the instructions of PC and software.

## Index Playback Of Files

You can view several different files stored in the memory card at a time. This browsing capability makes it easy to locate a particular file you want.

**1** For **Index Playback of image files**, perform steps **1 – 5** in “Normal Playback Of Images” (☞ pg. 30).

For **Index Playback of video clip files**, perform steps **1 – 3** in “Playback Of Video Clips” (☞ pg. 30).

**2** Press **INDEX**. The Index Screen of the selected type of file appears.

**3** Press **>** or **<** to move the frame to the desired file.

• Press **<** to display the previous page. Press **>** to display the next page.

**4** Press **SET**. The selected file is displayed.

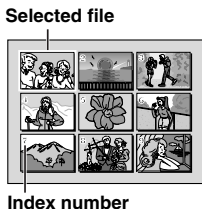

## Removing On-Screen Display

**1** Perform steps **1 – 3** in “Normal Playback Of Images” (☞ pg. 30).

**2** Press **MENU**. The Menu Screen appears.

**3** Press **Λ** or **∨** to select “DISPLAY”, and press **SET**. The Sub Menu appears.

**4** Press **Λ** or **∨** to select “OFF”, and press **SET**. The operation mode indicator, folder/file number and battery remaining power indicator disappear.

• To display the indicators again, select “ON”.

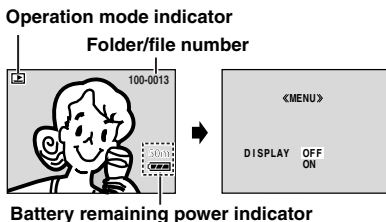

## Viewing File Information

You can get the relevant file information by pressing the **INFO** Button during normal playback or Index Playback.

**FOLDER:** Folder name (☞ pg. 33)

**FILE:** File name (☞ pg. 33)

**DATE:** Date the file was made

**SIZE:** Image size

**QUALITY:** Picture quality (IMAGE only)

**TIME:** Playback time (E-MAIL CLIP only)

**PROTECT:** When set to “ON”, the file is protected from accidental erasure. (☞ pg. 33)

• Press the **INFO** Button again to close the Information Screen.

### NOTE:

With images shot with other devices or processed on a PC, “QUALITY: ---” will be displayed.

FOLDER	: 100JVCGR
FILE	: DVC00010
DATE	: 27. 10. 04
SIZE	: 1024X768
QUALITY	: FINE
PROTECT	: OFF

## E-Mail Clip Recording

You can make video clips from real-time camera image or recorded video footage and store them in a memory card as files which can be conveniently sent via E-Mail.

### To make video clips from real-time camera image

- 1 Load a memory card. (☞ pg. 18)
- 2 Set the **VIDEO/MEMORY** Switch to "MEMORY".
- 3 Set the Power Switch to "A" or "M" while pressing down the Lock Button located on the switch.
  - "E-CLIP" appears.
- 4 Press **E-MAIL** to engage the E-Mail Clip Record-Standby mode.
  - "E-CLIP" appears.
- 5 Press the Recording Start/Stop Button to start recording.
- 6 Press the Recording Start/Stop Button to stop recording.
  - "COMPLETED" is displayed, then the camcorder re-enters the E-Mail Clip Record-Standby mode.
- 7 Press **E-MAIL** to end E-Mail Clip Recording.



### Approximate recording time

Image Size	SD Memory Card			
	8 MB*	16 MB	32 MB	64 MB
160 x 120	7 min.	15 min.	33 min.	68 min.

\* Provided (GR-DF570 only)

Image Size	MultiMediaCard		
	8 MB	16 MB	32 MB
160 x 120	8 min.	17 min.	34 min.

### To make video clips from recorded video footage

- 1 Load a cassette. (☞ pg. 17)
- 2 Load a memory card. (☞ pg. 18)
- 3 Set the **VIDEO/MEMORY** Switch to "VIDEO".
- 4 Set the Power Switch to "PLAY" while pressing down the Lock Button located on the switch.
- 5 Press **▶/II** to start video playback.
- 6 Press **E-MAIL** to engage the E-Mail Clip Record-Standby mode.
  - "E-CLIP" appears.
  - To cancel E-Mail Clip Recording, press **E-MAIL** again or press **■** to stop video playback.
- 7 At the point you want to start dubbing, press the Recording Start/Stop Button to start E-Mail Clip Recording.
- 8 Press the Recording Start/Stop Button to stop E-Mail Clip Recording.
  - "COMPLETED" is displayed, then the camcorder re-enters the E-Mail Clip Record-Standby mode.
- 9 Press **E-MAIL** to end E-Mail Clip Recording.





### NOTES:

- Approximate maximum recording time per video clip is 3 minutes.
- The video clip files stored with this camcorder are compatible with MPEG4. Some MPEG4 files stored with other devices cannot be played back with this camcorder.



## Dubbing Still Images Recorded On A Tape To A Memory Card

Still images can be dubbed from a tape to a memory card.

- 1** Load a cassette. (☞ pg. 17)
- 2** Load a memory card. (☞ pg. 18)
- 3** Set "SNAP/SLOW" to the desired mode. (except "SLOW", ☞ pg. 37, 38)
- 4** Set the **VIDEO/MEMORY** Switch to "VIDEO".
- 5** Set the Power Switch to "PLAY" while pressing down the Lock Button located on the switch.
- 6** Set "  COPY" to "ON". (☞ pg. 37, 42)
- 7** Press **▶/II** to start playback.
- 8** At the point you want to dub, press **▶/II** again to engage Still Playback.
- 9** To dub the image, press **SNAPSHOT**.
  - The "  indication appears during dubbing.

### NOTES:

- To use Playback Special effects with a video image you wish to dub, perform up to step **9** using the remote control. (☞ pg. 27)
- Images are dubbed in 640 x 480 pixels.

## Resetting The File Name

By resetting the file name, a new folder will be made. The new files you are going to make will be stored in the new folder. It is convenient to separate the new files from previously made files.

- 1 To reset the file name...**
  - ...for images, display its playback screen. (☞ pg. 30)
  - ...for video clips, display its playback screen. (☞ pg. 30)
- 2** Press **MENU**. The Menu Screen appears.
- 3** Press **Λ** or **V** to select "NO. RESET", and press **SET**. The NO. RESET screen appears.
- 4** Press **Λ** or **V** to select "EXECUTE", and press **SET**. The new folder (such as "101JVCGR") will be made and the file name of the next shot starts from DVC00001.

### NOTE:

If the file name reaches DVC09999, a new folder (such as "101JVCGR") will be made and the file name will start again from DVC00001.

## Protecting Files

The Protect mode helps prevent the accidental erasure of files.

### 1 To protect the file...

...for images, display its playback screen.

(☞ pg. 30)

...for video clips, display its playback screen.

(☞ pg. 30)

**2** Press **MENU**. The Menu Screen appears.

**3** Press **Λ** or **V** to select "PROTECT", and press **SET**. The Sub Menu appears.

### To protect the currently displayed file

**4** Press **Λ** or **V** to select "CURRENT", and press **SET**. The PROTECT screen appears.

**5** Press **<** or **>** to select the desired file.

**6** Press **Λ** or **V** to select "EXECUTE", and press **SET**.

- To cancel protection, select "RETURN".
- Repeat steps **5** and **6** for all files you want to protect.

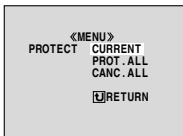

### To protect all files stored in the memory card

**4** Press **Λ** or **V** to select "PROT.ALL", and press **SET**. The PROTECT screen appears.

**5** Press **Λ** or **V** to select "EXECUTE", and press **SET**.

- To cancel protection, select "RETURN".

### NOTES:

- If the " mark appears, the currently displayed file is protected.
- When the memory card is initialised or corrupted, even protected files are deleted. If you do not want to lose important files, transfer them to a PC and save them.

## To Remove Protection

Before doing the following, perform steps **1 – 3** in "Protecting Files".

### To remove protection from the currently displayed file

**4** Press  $\blacktriangle$  or  $\blacktriangledown$  to select "CURRENT", and press **SET**. The PROTECT screen appears.

**5** Press  $\leftarrow$  or  $\rightarrow$  to select the desired file.

**6** Press  $\blacktriangle$  or  $\blacktriangledown$  to select "EXECUTE", and press **SET**.

- To cancel selection, select "RETURN".
- Repeat steps **5** and **6** for all files you want to remove protection.

### To remove protection from all files stored in the memory card

**4** Press  $\blacktriangle$  or  $\blacktriangledown$  to select "CANC.ALL", and press **SET**. The PROTECT screen appears.

**5** Press  $\blacktriangle$  or  $\blacktriangledown$  to select "EXECUTE", and press **SET**.

- To cancel selection, select "RETURN".

## Deleting Files

Previously stored files can be deleted either one at a time or all at once.

### 1 To delete the file...

...for images, display its playback screen.

( $\rightarrow$  pg. 30)

...for video clips, display its playback screen.

( $\rightarrow$  pg. 30)

**2** Press **MENU**. The Menu Screen appears.

**3** Press  $\blacktriangle$  or  $\blacktriangledown$  to select "DELETE", and press **SET**. The Sub Menu appears.

### To delete the currently displayed file

**4** Press  $\blacktriangle$  or  $\blacktriangledown$  to select "CURRENT", and press **SET**. The DELETE screen appears.

**5** Press  $\leftarrow$  or  $\rightarrow$  to select the desired file.

**6** Press  $\blacktriangle$  or  $\blacktriangledown$  to select "EXECUTE", and press **SET**.

- To cancel deletion, select "RETURN".
- Repeat steps **5** and **6** for all files you want to delete.

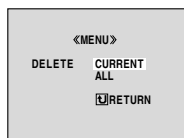

### NOTE:

If the "Ⓢ" mark appears, the selected file is protected and cannot be deleted.

### To delete all files stored in the memory card

**4** Press  $\blacktriangle$  or  $\blacktriangledown$  to select "ALL", and press **SET**. The DELETE screen appears.

**5** Press  $\blacktriangle$  or  $\blacktriangledown$  to select "EXECUTE", and press **SET**.

- To cancel deletion, select "RETURN".

### NOTES:

- Protected files ( $\rightarrow$  pg. 33) cannot be deleted. To delete them, remove protection first.
- Once files are deleted, they cannot be restored. Check files before deleting.

### CAUTION:

Do not remove the memory card or perform any other operation (such as turning off the camcorder) during deletion. Also, be sure to use the provided AC Adapter, as the memory card may be corrupted if the battery becomes exhausted during deletion. If the memory card becomes corrupted, initialise it. ( $\rightarrow$  pg. 36)

## Setting Print Information (DPOF Setting)

This camcorder is compatible with the DPOF (Digital Print Order Format) standard in order to support future systems such as automatic printing. You can select one of the 2 print information settings for images stored in the memory card: "To Print All Still Images (One Print For Each)" or "To Print By Selecting Still Images And Number Of Prints".

### NOTES:

- If you load a memory card already set as shown below in a printer compatible with DPOF, it will make prints of the selected still images automatically.
- To print images recorded on a tape, first dub them to a memory card. (➡ pg. 33)

### To Print All Still Images (One Print For Each)

**1** Perform steps **1 – 3** in "Normal Playback Of Images" (➡ pg. 30).

**2** Press **MENU**. The Menu Screen appears.

**3** Press  $\Delta$  or  $\nabla$  to select "DPOF", and press **SET**. The Sub Menu appears.

**4** Press  $\Delta$  or  $\nabla$  to select "ALL 1", and press **SET**. The DPOF screen appears.

**5** Press  $\Delta$  or  $\nabla$  to select "EXECUTE", and press **SET**. The normal playback screen appears.

- To cancel selection, select "RETURN".

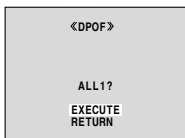
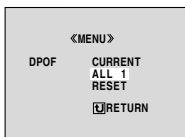

### To Print By Selecting Still Images And Number Of Prints

**1** Perform steps **1 – 3** in "To Print All Still Images (One Print For Each)".

**2** Press  $\Delta$  or  $\nabla$  to select "CURRENT", and press **SET**. The DPOF screen appears.

**3** Press  $\Delta$  or  $\nabla$  to select the desired file.

**4** Press  $\Delta$  or  $\nabla$  to select the number indication (00), and press **SET**.

**5** Select the number of prints by pressing  $\Delta$  to increase the number, or  $\nabla$  to decrease the number, and press **SET**.

- Repeat steps **3** through **5** for the desired number of prints.

- The number of prints can be set up to 15.
- To correct the number of prints, select the image again and change the number.

**6** Press  $\Delta$  or  $\nabla$  to select "RETURN", and press **SET**. The "SAVE?" appears.

- If you did not change any settings in step **3** through **5**, the Menu Screen reappears.

**7** Press  $\Delta$  or  $\nabla$  to select "EXECUTE" to save the setting you have just made, and press **SET**.

- To cancel selection, select "CANCEL".



## To Reset The Number Of Prints

- 1** Perform steps **1** – **3** in “To Print All Still Images (One Print For Each)”.
- 2** Press  $\wedge$  or  $\vee$  to select “RESET”, and press **SET**. The DPOF screen appears.
- 3** Press  $\wedge$  or  $\vee$  to select “EXECUTE”, and press **SET**. The normal playback screen appears.
  - To cancel selection, select “RETURN”.
  - The number of prints is reset to 0 for all still images.

### CAUTION:

While performing the above, never disconnect power, as this may cause the memory card to be corrupted.

## Initialising A Memory Card

You can initialise a memory card any time. After initialising, all files and data stored in the memory card, including those which have been protected, are cleared.

- 1** Set the **VIDEO/MEMORY** Switch to “MEMORY”.
- 2** Set the Power Switch to “PLAY” while pressing down the Lock Button located on the switch.
- 3** Press **MENU**. The Menu Screen appears.
- 4** Press  $\wedge$  or  $\vee$  to select “FORMAT”, and press **SET**. The **FORMAT** screen appears.
- 5** Press  $\wedge$  or  $\vee$  to select “EXECUTE”, and press **SET**. The memory card is initialised.

- When initialisation is finished, “NO IMAGES STORED” or “NO E-MAIL CLIP STORED” appears.
- To cancel initialisation, select “RETURN”.

### CAUTION:

Do not perform any other operation (such as turning off the camcorder) during initialisation. Also, be sure to use the provided AC Adapter, as the memory card may be corrupted if the battery becomes exhausted during initialisation. If the memory card becomes corrupted, initialise it.

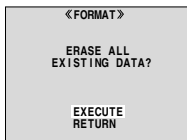

## Changing The Menu Settings

This camcorder is equipped with an easy-to-use, on-screen menu system that simplifies many of the more detailed camcorder settings. (pg. 38 – 42)

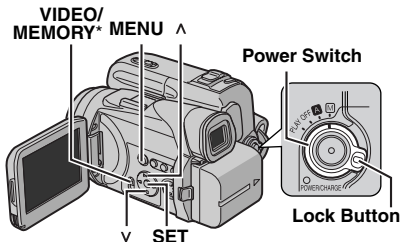

### 1 For Video and D.S.C.\* Recording Menus:

- Set the VIDEO/MEMORY Switch to "VIDEO" or "MEMORY".
- Set the Power Switch to "M" while pressing down the Lock Button located on the switch.

### For Video Playback Menus:

- Set the VIDEO/MEMORY Switch to "VIDEO".\*
- Set the Power Switch to "PLAY" while pressing down the Lock Button located on the switch.
- For D.S.C. Playback Menus, refer to "D.S.C. PLAYBACK (GR-DF570/470 only)" (pg. 30).\*

2 Open the LCD monitor fully. (pg. 19)

3 Press MENU. The Menu Screen appears.

4 Press  $\Delta$  or  $\nabla$  to select the desired function, and press SET. The selected function menu appears.

#### Screen for Video and D.S.C.\* Recording Menu

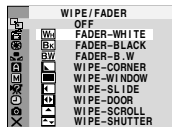

#### Screen for Video Playback Menu

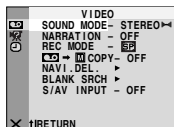

5 Setting procedure hereafter depends on the selected function.

\* GR-DF570/470 only

## Menus without Sub Menus

- WIPER/FADER (pg. 48)
- PROGRAM AE (pg. 48)
- EXPOSURE (pg. 45)
- W. BALANCE (pg. 47)

Selected menu icon blinks.

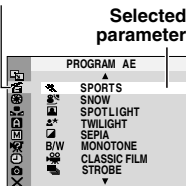

- 1) Press  $\Delta$  or  $\nabla$  to select the desired parameter.  
 • Example: PROGRAM AE Menu
- 2) Press SET. Selection is complete. The Menu Screen returns.  
 • Repeat the procedure if you wish to set other function menus.
- 3) Press SET. The Menu Screen closes.

## Menus with Sub Menus

- CAMERA (pg. 38)
- MANUAL (pg. 39)
- SYSTEM (pg. 39)
- CAMERA DISPLAY (pg. 40)
- DSC (pg. 41)\*
- VIDEO (pg. 41)
- VIDEO DISPLAY (pg. 42)

Selected menu icon blinks.

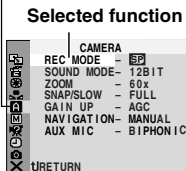

- 1) Press  $\Delta$  or  $\nabla$  to select the desired function, and press SET. The Sub Menu appears.  
 • Example: CAMERA Menu
- 2) Press  $\Delta$  or  $\nabla$  to select the desired parameter.
- 3) Press SET. Selection is complete.

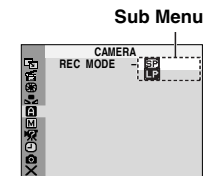

- Repeat the procedure if you wish to set other function menus.
- 4) Press SET. The Menu Screen returns.
- Repeat the procedure if you wish to set other function menus.
- 5) Press SET. The Menu Screen closes.

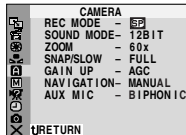

\* GR-DF570/470 only

## Recording Menus

### CAMERA

The **[CAMERA]** settings are effective when the Power Switch is set to both **[A]** and **[M]**. However, the menu settings can be changed only when the Power Switch is set to **[M]**.

[ ] = Factory-preset

### REC MODE

**[SP]**: To record in the SP (Standard Play) mode  
**[LP]**: Long Play—more economical, providing 1.5 times the recording time.

### NOTES:

- Audio Dubbing (☞ pg. 55) and Insert Editing (☞ pg. 56) are possible on tapes recorded in the SP mode.
- If the recording mode is switched, the playback picture will be blurred at the switching point.
- It is recommended that tapes recorded in the LP mode on this camcorder be played back on this camcorder.
- During playback of a tape recorded on another camcorder, blocks of noise may appear or there may be momentary pauses in the sound.

### SOUND MODE

**[12BIT]**: Enables video recording of stereo sound on four separate channels, and is recommended for use when performing Audio Dubbing. (Equivalent to the 32 kHz mode of previous models)

**16BIT**: Enables video recording of stereo sound on two separate channels. (Equivalent to the 48 kHz mode of previous models)

### ZOOM

**15X**: When set to “15X” while using digital zoom, the zoom magnification will reset to 15X since digital zoom will be disengaged.

**[60X]\***: Allows you to use the Digital Zoom. By digitally processing and magnifying images, zooming is possible from 15X (the optical zoom limit), to a maximum of 60X digital magnification.

**700X\***: Allows you to use the Digital Zoom. By digitally processing and magnifying images, zooming is possible from 15X (the optical zoom limit), to a maximum of 700X digital magnification.

\* Available only when the **VIDEO/MEMORY** Switch is set to “VIDEO”. (GR-DF570/470 only)

### SNAP/SLOW

**[FULL]**: Snapshot mode with no frame

**NEGA**: Nega mode

**PIN-UP**: Pin-Up mode

**FRAME**: Snapshot mode with frame

**SLOW**: Live Slow mode



[FULL]



NEGA



PIN-UP





FRAME

For details on the procedure, refer to “Live Slow (GR-DF570/470 only)” (☞ pg. 43) and “Snapshot (For Video Recording)” (☞ pg. 44).

### GAIN UP

**OFF**: Allows you to shoot dark scenes with no picture brightness adjustment.

**[AGC]**: The overall appearance may be grainy, but the image is bright.

**AUTO** : The shutter speed is automatically adjusted. Shooting a subject in low or poor lighting at slow shutter speed provides a brighter image than in the AGC mode, but the subject's movements are not smooth or natural. The overall appearance may be grainy. While the shutter speed is being automatically adjusted, “A” is displayed.

### NAVIGATION

(GR-DF570/470 only)

**[MANUAL]**: Enables thumbnail images to be made manually. (☞ pg. 50)

**5SEC / 15SEC / 30SEC / 60SEC**:

The captured image is stored in the memory card as a thumbnail image when the recording time is over the navigation time.

For example, “5SEC” is suitable to record short scenes with the thumbnail images. (☞ pg. 49) However, the stored thumbnail images may take up a lot of memory. In this case, using the memory card with large capacity is recommended.

**OFF**: Disables the function.

- The **[MAN]** indicator appears when “NAVIGATION” is set to other than “MANUAL” and “OFF”.

### AUX MIC

(GR-DF570/470 only)

**OFF**: Disables Biphonic Recording.

**[BIPHONIC]**: Enables Biphonic Recording. (☞ pg. 51)

**MANUAL**

The **MANUAL** settings are effective only when the Power Switch is set to **MAN**.

[ ] = Factory-preset

**DIS**

**OFF:** Disables the function.

**[ON] (DIS):** To compensate for unstable images caused by camera-shake, particularly at high magnification.

**NOTES:**

- Accurate stabilisation may not be possible if hand shake is excessive, or depending on the shooting condition.
- The **(DIS)** indicator blinks or goes out if the Stabiliser cannot be used.
- Switch off this mode when recording with the camcorder on a tripod.

**5S**

**[OFF]:** Disables 5-Second Recording.

**5S:** Enables 5-Second Recording. (☞ pg. 43)

**Anim.:** Allows you to record a few frames only.

By using an inanimate object and changing its position between shots, you can record the subject as though it is moving.

**TELE MACRO**

**[OFF]:** Disables the function.

**ON:** When the distance to the subject is less than 1 m, set "TELE MACRO" to "ON". You can shoot a subject as large as possible at a distance of approx. 50 (60\*) cm.

\* GR-DF470/430 only

**NOTE:**

Depending on the zoom position, the lens may go out of focus.

**WIDE MODE**

**[OFF]:** Records with no change in the screen ratio. For playback on a TV with a normal screen ratio.

**CINEMA\*\* [ ]:** Inserts black bands at the top and bottom of the screen. The [ ] indicator appears. During playback on wide-screen TVs, the black bands at the top and bottom of the screen are cut and the screen ratio becomes 16:9. When using this mode, refer to your wide-screen TV's instruction manual. During playback/recording on 4:3 TVs/LCD monitor/viewfinder, black bands are inserted at the top and bottom of the screen and the image appears like a letter boxed 16:9 movie.

**SQUEEZE\*\* [ ]:** For playback on TVs with an aspect ratio of 16:9. Naturally expands the image to fit the screen without distortion. The [ ] indicator appears. When using this mode, refer to your wide-screen TV's instruction manual. During playback/recording on 4:3 TVs/LCD monitor/viewfinder, the image is elongated vertically.

**D.WIDE\*\* [ ]:** The [ ] indicator appears. The zoom range is extended beyond the maximum optical zoom wide angle range. This mode's wide angle setting is equivalent to using a 0.7X wide conversion lens. Zooming is possible from 0.7X to 10X. This mode is suitable for shooting in a small room. (GR-DF570 only)

\*\* Available only when the **VIDEO/MEMORY** Switch is set to "VIDEO". (GR-DF570/470 only)

**WIND CUT**

**[OFF]:** Disengages the function.

**ON [ ]:** Helps cut down on noise created by wind. The " [ ] " indicator appears. The quality of the sound will change. This is normal.

**SYSTEM**

The **SYSTEM** functions which are set when the Power Switch is set to **MAN** are also applied when the Power Switch is set to "PLAY".

[ ] = Factory-preset

**BEEP**

**OFF:** Even though not heard while shooting, shutter sound is recorded on the tape.

**BEEP:** The beep sounds when the power is turned on or off, and at the beginning and end of recording. It also activates the shutter sound effect. (☞ pg. 28, 44)

**[MELODY]:** Instead of a beep, a melody sounds when any operation is performed. It also activates the shutter sound effect.

(☞ pg. 28, 44)

**REMOTE**

**OFF:** Disables the remote control operations.  
**[ON]:** Enables the remote control operations.

**DEMO MODE**

**OFF:** Automatic demonstration will not take place.  
**[ON]:** Demonstrates certain functions such as Program AE with special effects, etc., and can be used to confirm how these functions operate. Demonstration starts in the following cases:

- When the Menu Screen is closed after "DEMO MODE" is turned "ON".
- With "DEMO MODE" set to "ON", if there is no operation for about 3 minutes after the Power Switch is set to "A" or "M".
- Performing any operation during the demonstration stops the demonstration temporarily. If no operation is performed for more than 3 minutes after that, the demonstration will resume.

**NOTES:**

- If a cassette is in the camcorder, the demonstration cannot be turned on.
- "DEMO MODE" remains "ON" even if the camcorder power is turned off.
- If "DEMO MODE" remains "ON", some functions will not be available. After viewing demo, set to "OFF".

**PRIORITY**

**[LCD]:** The image is displayed on the LCD monitor when the viewfinder is pulled out while the LCD monitor is opened.



**FINDER:** The image is displayed in the viewfinder when the viewfinder is pulled out while the LCD monitor is opened.

**CAM RESET**

**EXECUTE:** Resets all settings to the factory-preset.

**[RETURN]:** Does not reset all settings to the factory-preset.

** CAMERA DISPLAY**

- The " (CAMERA DISPLAY) settings are effective even when the Power Switch is set to "A". However, the menu settings can be changed only when the Power Switch is set to "M".
- The " (CAMERA DISPLAY) settings except "BRIGHT" and "AUDIO LEV." are effective only for shooting.

[ ] = Factory-preset

**BRIGHT**

 pg. 17, "Brightness Adjustment Of The Display"

**ON SCREEN**

**LCD:** Keeps the camcorder's display (except the date, time and time code) from appearing on the connected TV screen.

**[LCD/TV]:** Makes the camcorder's display appear on screen when the camcorder is connected to a TV.

**DATE/TIME**

**OFF:** The date/time does not appear.

**[AUTO]:** Displays the date/time for approx. 5 seconds when the Power Switch is set from "OFF" to "A" or "M".

**ON:** The date/time is always displayed.

- The date indication can also be turned on/off by pressing the **DISPLAY** Button on the remote control. ( pg. 23, 52)

**TIME CODE**

**[OFF]:** Time code is not displayed.

**ON:** Time code is displayed on the camcorder and on the connected TV. Frame numbers are not displayed during recording. ( pg. 21)

**LANGUAGE**

For GR-DF570/470

**[ENGLISH] / FRANÇAIS / DEUTSCH / ESPAÑOL / ITALIANO / NEDERLANDS / PORTUGUÊS / РУССКИЙ /** فارسی / عربي / 中文 / 汉语

For GR-DF430

**[ENGLISH] /** 汉语

The language setting can be changed.

( pg. 16)

**NOTE:**

Models for China, the factory-preset language is simplified Chinese.

**AUDIO LEV.**

**[OFF]:** Auxiliary microphone level indicator does not appear.

**ON:** Displays auxiliary microphone level indicator when optional microphone is connected. ( pg. 8)

**CLOCK ADJ.**

 pg. 16, "Date/Time Settings"





 **DSC (GR-DF570/470 only)**

[ ] = Factory-preset

**QUALITY**

[FINE] / STANDARD

The Picture Quality mode can be selected to best match your needs. Two Picture Quality modes are available: FINE () and STANDARD () (in order of quality).

**NOTE:**

The number of storable images depends on the selected picture quality as well as the composition of the subjects in the images and the type of memory card being used. (➡ pg. 28)

**IMAGE SIZE**

640 x 480 / 1024 x 768 / [1152 x 864]\* / 1600 x 1200\*

The Image Size mode can be selected to best match your needs. (➡ pg. 28)



\* GR-DF570 only

**NOTE:**

The setting can be changed only when the VIDEO/MEMORY Switch is set to "MEMORY".

**REC SELECT**

[ (TAPE)]: When Snapshot recording is performed with the VIDEO/MEMORY Switch set to "VIDEO", still images are recorded only onto the tape.

➡ [] / [] (TAPE/CARD): When Snapshot recording is performed with the VIDEO/MEMORY Switch set to "VIDEO", still images are recorded not only onto the tape but also in the memory card (640 x 480 pixels). In this mode, the "SNAP/SLOW" selection in CAMERA Menu is also applicable to memory card recording.

**INT.SHOT**

[OFF]: Disables the function.

ON: Enables interval shooting. (➡ pg. 29)

**INT.TIME**

15SEC / 30SEC / [1MIN] / 2MIN / 5MIN / 10MIN / 30MIN / 60MIN

Allows you to select the shooting interval for interval shooting. (➡ pg. 29)

**Playback Menus**

 **VIDEO**

[ ] = Factory-preset

**SOUND MODE and NARRATION**

During tape playback, the camcorder detects the sound mode in which the recording was made, and plays the sound back. Select the type of sound to accompany your playback picture. According to the menu access explanation on page 37, select "SOUND MODE" or "NARRATION" from the Menu Screen and set it to the desired parameter.

**SOUND MODE**

[STEREO ]: Sound is output on both "L" and "R" channels in stereo.

**SOUND L** : Sound from the "L" channel is output.

**SOUND R** : Sound from the "R" channel is output.

**NARRATION**

[OFF]: Original sound is output on both "L" and "R" channels in stereo.

ON: Dubbed sound is output on both "L" and "R" channels in stereo. (➡ pg. 55)

**MIX:** Original and dubbed sounds are combined and output in stereo on both "L" and "R" channels.

**REC MODE** [SP] / LP

Allows you to set the video recording mode (SP or LP) depending on your preference. It is recommended you use "REC MODE" in VIDEO Menu when using this camcorder as a recorder during dubbing. (☞ pg. 52, 53)

**📷➡️📺 COPY** (GR-DF570/470 only)

**[OFF]:** When the **SNAPSHOT** button is pressed during tape playback, the playback image pauses and normal playback will resume after approximately 6 seconds. (The still image is not recorded.)

**ON:** Enables dubbing of images recorded on a tape to a memory card. (☞ pg. 33)

**NAVI.DEL.****IMAGE SEL. / TAPE SEL. / ALL / RETURN**

☞ pg. 50, "To delete thumbnail images"

**BLANK SRCH**

☞ pg. 22, "Blank Search"

**S/AV INPUT**

**[OFF]:** Disables audio/video signal input from the AV and S-Video connectors. (☞ pg. 52)

**ON:** Enables audio/video signal input from the AV and S-Video connectors. (☞ pg. 52)

**NOTE:**

When set to "ON", the S-video input has a priority to the composite video input.

**🔗 SYSTEM**

Each setting is linked with "🔗 SYSTEM", which appears when the Power Switch is set to "📺". (☞ pg. 37)

- The parameters are the same as in the description on page 39.

**📺 VIDEO DISPLAY**

The "📺" (VIDEO DISPLAY) settings are effective only for video playback except "BRIGHT" and "AUDIO LEV."

- The parameters (except "OFF" in ON SCREEN settings) are the same as in the description (CAMERA DISPLAY) on page 40.

[ ] = Factory-preset

**BRIGHT**

☞ pg. 17, "Brightness Adjustment Of The Display"

**ON SCREEN** OFF / [LCD] / LCD/TV

When set to "OFF", the camcorder's display disappears.

**DATE/TIME** [OFF] / AUTO / ON

When set to "AUTO", the date/time are displayed in the following cases:

- When playback starts. The camcorder displays the date/time when scenes are recorded.
- When the date is changed during playback.

**TIME CODE** [OFF] / ON

☞ pg. 21, "Time Code"

**LANGUAGE**

For GR-DF570/470

**[ENGLISH] / FRANÇAIS / DEUTSCH / ESPAÑOL / ITALIANO / NEDERLANDS / PORTUGUÊS / РУССКИЙ / فارسی / عربي / 中文 / 汉语**

For GR-DF430

**[ENGLISH] / 汉语**

The language setting can be changed.

(☞ pg. 16)

**NOTE:**

Models for China, the factory-preset language is simplified Chinese.

**AUDIO LEV.** [OFF] / ON

☞ pg. 40, "AUDIO LEV."

## LED Light (GR-DF570/470 only)

LED Light can be used to brighten the subject in the dark place during video recording or D.S.C. shooting.

**1** Press **LIGHT** repeatedly to change the setting.

**OFF:** Turns off the light.

**ON:** The light is on always. (☞) appears.)

**AUTO:** The light turns on automatically when dark. (☞) **A** appears.)

**2** Press the Recording Start/Stop Button to start video recording or **SNAPSHOT** to shoot a still image.

### NOTES:

- Be careful not to point the LED Light directly to eyes.
- If the light does not reach the subject, the Night Alive function will be activated, and makes it possible to shoot the subject brighter.
- There is a difference in the brightness of the images shot between the centre area which is illuminated by the LED Light and the surrounding areas (which will be darker).
- Since subjects are shot at a reduced shutter speed when the LED Light setting is "ON", they will appear slightly blurred.

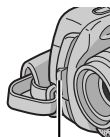

LED Light

## 5-Second Recording

Record a vacation or an important event in 5-second clips to keep the action moving. This function is available only for video recording.

**1** Set "5S" to "5S". (☞ pg. 39)

- The "5S" indicator appears.

**2** Press the Recording Start/Stop Button to start recording, and after 5 seconds the camcorder enters Record-Standby mode automatically.

- Even if you press the Recording Start/Stop Button again within 5 seconds after recording starts, Record-Standby mode is not engaged.

**3** To exit the 5S mode, select "OFF" in step **1**.

### To take a snapshot in the 5-second recording mode

Instead of pressing the Recording Start/Stop Button in step **2**, select the desired Snapshot mode in CAMERA Menu (☞ pg. 38), then press **SNAPSHOT**. The camcorder records a 5-second still. When "5S" is set to "Anim.", this function is not available.

### NOTE:

When "5S" is set to "Anim.", the 5-Second Recording mode is not available. Animation recording of a few frames only is taken instead.

## Live Slow (GR-DF570/470 only)

This feature is useful for recording or playing back precious or hard-to-see moments at a slow speed. Sound is recorded and played back in real time.

**1** Set the **VIDEO/MEMORY** Switch to "VIDEO".

**2** Set "SNAP/SLOW" to "SLOW".

(☞ pg. 37, 38) The Live Slow indicator "Ⓛ" appears.

**3** Press **SLOW** during recording or playback.

- The moving pictures are divided into four frames. They are recorded or played back for 1.5 seconds, and then normal recording or playback resumes.

## Night-Alive

Makes dark subjects or areas even brighter than they would be under good natural lighting. Although the recorded image is not grainy, it may look as if it is strobing due to the slow shutter speed.

- 1 Set the Power Switch to "M".
- 2 Set "A" to "NIGHTALIVE". (➡ pg. 48) The Night-Alive indicator "0.0" appears.
  - The shutter speed is automatically adjusted to provide up to 25 times sensitivity.
  - "A" appears beside "0.0" while the shutter speed is being automatically adjusted.

### To deactivate Night-Alive

Set "A" to "OFF" so that the Night-Alive indicator disappears.

### NOTES:

- During Night-Alive, the following functions or settings cannot be activated and its indicator blinks or goes out:
  - Some modes of "Program AE With Special Effects" (➡ pg. 48).
  - "GAIN UP" in CAMERA Menu (➡ pg. 38).
  - "DIS" in MANUAL Menu (➡ pg. 39).
- During Night-Alive, it may be difficult to bring the camcorder into focus. To prevent this, use of a tripod is recommended.

## Snapshot (For Video Recording)

This feature lets you record still images that look like photographs onto a tape.

- 1 Set the VIDEO/MEMORY Switch to "VIDEO". (GR-DF570/470 only)
- 2 Set the Power Switch to "M".
- 3 Set "SNAP/SLOW" to the desired mode. (➡ pg. 37, 38) The Snapshot indicator "A" appears.
- 4 Press **SNAPSHOT**.
  - There is the sound effect of a shutter closing.
  - The "PHOTO" indication appears and a still image will be recorded for approx. 6 seconds, then the camcorder re-enters the Record-Standby mode.
  - You can perform Snapshot also during recording. A still image will be recorded for approx. 6 seconds, then the normal recording resumes.
  - Regardless of the Power Switch position ("A" or "M"), Snapshot recording takes place using the selected Snapshot mode.

## Motor Drive Mode

Keeping **SNAPSHOT** pressed in step 4 provides an effect similar to serial photography. (Interval between still images: approx. 1 second)

- The Motor Drive mode is disabled when "REC SELECT" is set to "▶ A/▶ M". (➡ pg. 41)

## Manual Focus

The camcorder's Full Range AF system offers continuous shooting ability from close-up (as close as approx. 5 cm to the subject) to infinity. However, correct focus may not be obtained depending on the shooting condition. In this case, use the manual focus mode.

**1** Set the Power Switch to "M".

**2** Press **FOCUS**. The manual focus indicator appears.

**3** Press < or > to focus on a subject.

• When the focus level cannot be adjusted any further or closer, "▲" or "▶" will blink.

**4** Press **SET**. Focus adjustment is complete.

### To reset to Auto Focus

Press **FOCUS** twice or set the Power Switch to "A".

**Manual focus is recommended in situations listed below.**

- When two subjects overlap in the same scene.
- When illumination is low.\*
- When the subject has no contrast (difference in brightness and darkness), such as a flat, one-colour wall, or a clear, blue sky.\*
- When a dark object is barely visible in the LCD monitor or the viewfinder.\*
- When the scene contains minute patterns or identical patterns that are regularly repeated.
- When the scene is affected by sunbeams or light reflecting off the surface of a body of water.
- When shooting a scene with a high-contrast background.

\* The following low-contrast warnings appear blinking: ▲, ◀, ▶ and ▶.



Manual focus indicator

## Exposure Control

Manual exposure control is recommended in the following situations:

- When shooting using reverse lighting or when the background is too bright.
- When shooting on a reflective natural background such as at the beach or when skiing.
- When the background is overly dark or the subject is bright.

**1** Set the Power Switch to "M".

**2** Set "E" to "MANUAL". (☞ pg. 37)

• The exposure control indicator appears.

**3** To brighten the image, press >. To darken the image, press <. (maximum ±6)

• +3 exposure has the same effect as the backlight compensation. (☞ pg. 46)

• -3 exposure has the same effect as when "E" is set to "SPOTLIGHT". (☞ pg. 49)

**4** Press **SET**. Exposure adjustment is complete.

### To return to automatic exposure control

Select "AUTO" in step 2. Or, set the Power Switch to "A".

### NOTES:

- You cannot use the manual exposure control at the same time when "E" is set to "SPOTLIGHT" or "SNOW" (☞ pg. 48), or with the backlight compensation.
- If the adjustment does not cause any visible change in brightness, set "GAIN UP" to "AUTO". (☞ pg. 37, 38)

## Iris Lock

Like the pupil of the human eye, the iris contracts in well-lit environments to keep too much light from entering, and dilates in dim environments to allow in more light.

Use this function in the following situations:

- When shooting a moving subject.
- When the distance to the subject changes (so its size in the LCD monitor or the viewfinder changes), such as when the subject is backing away.
- When shooting on a reflective natural background such as at the beach or when skiing.
- When shooting objects under a spotlight.
- When zooming.

**1** Set the Power Switch to "M".

**2** Set "☞" to "MANUAL". (☞ pg. 37)

- The exposure control indicator appears.

**3** Adjust zoom so that the subject fills the LCD monitor or the viewfinder, then press and hold **SET** for over 2 seconds. The exposure control indicator and the "☞" indication appear.

**4** Press **SET**. The "☞" indication changes to "☞" and the iris is locked.

### To return to automatic iris control

Select "AUTO" in step **2**. Or, set the Power Switch to "A".

- The exposure control indicator and "☞" disappear.

### To lock the exposure control and the iris

After step **2**, adjust the exposure by pressing  $\wedge$  or  $\vee$ . Then lock the iris in steps **3** and **4**. For automatic locking, select "AUTO" in step **2**. The exposure control and the iris become automatic.

## Backlight Compensation

Backlight compensation brightens the subject quickly.

With simple operation, backlight compensation feature brightens the dark subject portion by increasing the exposure.

**1** Set the Power Switch to "M".

**2** Press **BACK LIGHT** so that the Backlight Compensation indicator "☞" appears.

### To cancel Backlight Compensation

Press **BACK LIGHT** twice so that the "☞" indicator disappears.

### NOTE:

Using Backlight Compensation may cause the light around the subject to become too bright and the subject to become white.

## Spot Exposure Control

Selection of a spot metering area enables more precise exposure compensation. You can select one of the three metering areas on the LCD monitor/viewfinder.

**1** Set the Power Switch to "M".

**2** Press **BACK LIGHT** twice so that the Spot Exposure Control indicator "☞" appears.

- A spot metering area frame appears at the centre of the LCD monitor/viewfinder.

**3** Press  $>$  or  $<$  to select the desired spot metering area frame.

**4** Press **SET**.

- Spot Exposure Control is engaged.
- Exposure is adjusted to make the brightness of the selected area most appropriate.

### To lock the iris

After step **3**, press and hold **SET** over 2 seconds. The "☞" indication appears and the iris is locked.

### To cancel Spot Exposure Control

Press **BACK LIGHT** once so that the "☞" indicator disappears.

### NOTES:

- You cannot use the Spot Exposure Control at the same time with following functions.
  - "SQUEEZE" in "WIDE MODE" (☞ pg. 39)
  - "STROBE" in "PROGRAM AE" (☞ pg. 48)
  - Digital Zoom (☞ pg. 20)
  - Manual Exposure Control
- Depending on the shooting location and condition, optimum result may not be attained.

## White Balance Adjustment

The white balance refers to the correctness of colour reproduction under various lighting. If the white balance is correct, all other colours will be accurately reproduced.

The white balance is usually adjusted automatically. However, more advanced camcorder operators control this function manually to achieve a more professional colour/tint reproduction.

### To change the setting

Set "☑" to the desired mode. (☞ pg. 37)

- The selected mode indicator except "AUTO" appears.

**[AUTO]:** White balance is adjusted automatically.

☑ **MWB:** Adjust the white balance manually when shooting under various types of lighting.

(☞ "Manual White Balance Adjustment")

☀ **FINE:** Outdoors on a sunny day.

☁ **CLOUD:** Outdoors on a cloudy day.

☀ **HALOGEN:** A video light or similar type of lighting is used.

[ ] = Factory-preset

### To return to automatic white balance

Set "☑" to "AUTO". (☞ pg. 37)

Or, set the Power Switch to "A".

## Manual White Balance Adjustment

Adjust the white balance manually when shooting under various types of lighting.

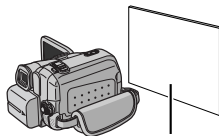

White paper

**1** Set the Power Switch to "☑".

**2** Select "MWB" in "☑ W.BALANCE" menu. (☞ pg. 37)

- The ☑ indication blinks slowly.

**3** Hold a sheet of plain white paper in front of the subject. Adjust zoom or position yourself so that the white paper fills the screen.

**4** Press and hold **SET** until ☑ begins blinking rapidly.

- When the setting is completed, ☑ resumes normal blinking.

**5** Press **SET** twice. The Menu Screen closes and the Manual White Balance indicator ☑ is displayed.

### NOTES:

- In step **3**, it may be difficult to focus on the white paper. In such a case, adjust focus manually. (☞ pg. 45)
- A subject can be shot under various types of lighting conditions indoors (natural, fluorescent, candlelight, etc.). Because the colour temperature is different depending on the light source, the subject tint will differ depending on the white balance settings. Use this function for a more natural result.
- Once you adjust white balance manually, the setting is retained even if the power is turned off or the battery removed.

## Wipe Or Fader Effects

These effects let you make pro-style scene transitions. Use them to spice up the transition from one scene to the next.

Wipe or Fader works when video recording is started or stopped.

**1** Set the **VIDEO/MEMORY** Switch to "VIDEO". (GR-DF570/470 only)

**2** Set the Power Switch to "M".

**3** Set "E" to the desired mode. (☞ pg. 37)

- The WIPE/FADER menu disappears and the effect is reserved.
- The selected effect indicator appears.

**4** Press the Recording Start/Stop Button to activate the Fade-in/out or Wipe-in/out.

### To deactivate the selected effect

Select "OFF" in step **3**. The effect indicator disappears.

### NOTES:

- You can extend the length of a Wipe or Fader by pressing and holding the Recording Start/Stop Button.
- Some Wipe/Fader Effects cannot be used with certain modes of Program AE with special effects. (See the right column.) In this case, the selected indicator blinks or goes out.

## E WIPE/FADER

**OFF:** Disables the function. (Factory-preset)

**Wh FADER-WHITE:** Fade in or out with a white screen.

**Bk FADER-BLACK:** Fade in or out with a black screen.

**BW FADER-B.W:** Fade in to a colour screen from a black and white screen, or fade out from colour to black and white.

**☐ WIPE-CORNER:** Wipe in on a black screen from the upper right to the lower left corner, or wipe out from lower left to upper right, leaving a black screen.

**☐ WIPE-WINDOW:** The scene starts in the centre of a black screen and wipes in toward the corners, or comes in from the corners, gradually wiping out to the centre.

**☐ WIPE-SLIDE:** Wipe in from right to left, or wipe out from left to right.

**☐ WIPE-DOOR:** Wipe in as the two halves of a black screen open to the left and right, revealing the scene, or wipe out and the black screen reappears from left and right to cover the scene.

**☐ WIPE-SCROLL:** The scene wipes in from the bottom to the top of a black screen, or wipes out from top to bottom, leaving a black screen.

**☐ WIPE-SHUTTER:** Wipe in from the centre of a black screen toward the top and bottom, or wipe out from the top and bottom toward the centre leaving a black screen.

## Program AE With Special Effects

**1** Set the Power Switch to "M".

**2** Set "E" to the desired mode. (☞ pg. 37)

- The PROGRAM AE menu disappears and the selected effect is activated.
- The selected effect indicator appears.

### To deactivate the selected effect

Select "OFF" in step **2**. The effect indicator disappears.

### NOTES:

- Program AE with special effects can be changed during recording or during Record-Standby.
- Some modes of Program AE with special effects cannot be used during Night-Alive.
- When a subject is too bright or reflective, a vertical streak may appear (smear phenomenon). Smear phenomenon tends to occur when "SPORTS" or any mode of "SHUTTER 1/250 – 1/4000" is selected.
- Some modes of Program AE with special effects cannot be used with certain Wipe/Fader effects. (See the left column.) In this case, the selected indicator blinks or goes out.



**PROGRAM AE**

**OFF:** Disables the function. (Factory-preset)

**NIGHTALIVE:** (☞ pg. 44)

**1/50 SHUTTER 1/50:** The shutter speed is fixed at 1/50th of a second. Black bands that usually appear when shooting a TV screen become narrower.

**1/120 SHUTTER 1/120:** The shutter speed is fixed at 1/120th of a second. The flickering that occurs when shooting under a fluorescent light or mercury-vapour lamp is reduced.

**SHUTTER 1/250/ SHUTTER 1/500/**

**SHUTTER 1/1000\*/ SHUTTER 1/2000\*/**

**SHUTTER 1/4000\*:** These settings allow fast-moving images to be captured one frame at a time, for vivid, stable slow-motion playback by fixing shutter speed variables. Use these settings when an automatic adjustment does not work well, using **SPORTS** mode. The faster the shutter speed, the darker the picture becomes. Use the shutter function under good lighting conditions.

**SPORTS**

**(Variable Shutter Speed: 1/250 – 1/4000):**

This setting allows fast-moving images to be captured one frame at a time, for vivid, stable slow-motion playback. The faster the shutter speed, the darker the picture becomes. Use the shutter function under good lighting conditions.

**SNOW:** Compensates for subjects that may otherwise appear too dark when shooting in extremely bright surroundings such as in the snow.

**SPOTLIGHT:** Compensates for subjects that may otherwise appear too bright when shooting under extremely strong direct lighting such as spotlights.

**TWILIGHT:** Makes evening scenes look more natural. White Balance (☞ pg. 47) is automatically set to “☉”, but can be changed to your desired setting. When Twilight is chosen, the camcorder automatically adjusts the focus from approx. 10 m to infinity. From less than 10 m, adjust the focus manually.

**SEPIA:** Recorded scenes have a brownish tint like old photos. Combine this with the Cinema mode for a classic look.

**B/W MONOTONE:** Like classic black and white films, your footage is shot in B/W. Used together with the Cinema mode, it enhances the “classic film” effect.

**CLASSIC FILM\*:** Gives recorded scenes a strobe effect.

**STROBE\*:** Your recording looks like a series of consecutive snapshots.

**MIRROR\*:** Creates a mirror image on the right half of the screen, juxtaposed to the normal image on the other half.

\* Available only when the **VIDEO/MEMORY** Switch is set to “VIDEO”. (GR-DF570/470 only)

**Navigation Function (GR-DF570/470 only)**

The Navigation Function helps you check tape contents by making thumbnail images on a memory card.

**Before continuing**

To use Navigation functions, load a cassette and memory card, then set the **VIDEO/MEMORY** Switch to “VIDEO”.

**To make thumbnail images during video recording automatically**

**1** Set “NAVIGATION” to the desired navigation storing time. (☞ pg. 37, 38)

• If the “**NAVIGATION**” indicator appears blinking on the screen, wait until it stops blinking. If it does not stop blinking after a while, check if a memory card is loaded.

**2** Set the Power Switch to “**A**” or “**M**”.

**3** Press the Recording Start/Stop Button to start recording.

• When the recording time is over the navigation time set in step **1**, “**NAVIGATION**” appears briefly, then the image of the point where recording is started is captured and stored in the memory card as a thumbnail image.

• If the Recording Start/Stop button is pressed before “**NAVIGATION**” stops blinking, the image of the point where the loaded memory card is recognised is captured.

**4** Press the Recording Start/Stop Button to stop recording.

**To make thumbnail images after video recording manually**

- 1 Set "NAVIGATION" to "MANUAL".  
(☞ pg. 37, 38)
- 2 Set the Power Switch to "A" or "M".
- 3 After the recording, press **STORE**.
  - The "☑" indicator appears briefly and the captured image is stored in the memory card as a thumbnail image.

**NOTES:**

- The remaining number of storable thumbnail images also appears on the screen when it reaches 10 or less. If "REC SELECT" is set to "☑" or "M" in DSC Menu, the number shows how many 640 x 480 pixel images can be stored.
- If "5S" is set to "5S" or "Anim." in MANUAL Menu, the NAVIGATION function will not work properly.

**To find scenes on tape using thumbnail images (Navigation Search)**

- 1 Set the Power Switch to "PLAY".
- 2 Press **INDEX** during video playback or stop mode.
  - The loaded cassette's Navigation thumbnail image screen appears.

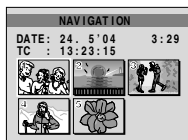

- 3 Press >/</v to select the desired image, and press **SET**.
  - The "NAVIGATION SEARCH" indication appears blinking and the camcorder starts searching the tape for the relevant point of the selected thumbnail image.

**To cancel Navigation search midway**

Press ►/II, ◀◀, ▶▶ or ■.

**To add thumbnail images during video playback**

- 1 Set the Power Switch to "PLAY".
- 2 Press ►/II to start video playback.
- 3 Press **STORE** at the desired point.
  - The "☑" indicator appears briefly and the image of the point where **STORE** is pressed is stored in the memory card as a thumbnail image.

**To delete thumbnail images**

- 1 Set the Power Switch to "PLAY".
- 2 Press **MENU**. The Menu Screen appears.
- 3 Press **SET** to select "☑". The VIDEO Menu appears.
- 4 Press  $\wedge$  or  $\vee$  to select "NAVI.DEL.", and press **SET**. The Sub Menu appears.
- 5 By pressing  $\wedge$  or  $\vee$ :
  - Select "IMAGE SEL." to delete the currently displayed thumbnail image.
  - Select "TAPE SEL." to delete all thumbnail images for the tape which contains the currently displayed image.
  - Select "ALL" to delete all thumbnail images stored in the memory card at once.
- 6 Press **SET**. The NAVIGATION screen appears.
- 7 Press  $\wedge$  or  $\vee$  to select "EXECUTE", and press **SET**.
  - Press < to display the previous image. Press > to display the next image.
  - To cancel deletion, select "RETURN".
  - Thumbnail images cannot be deleted during video playback.

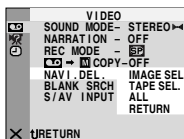

**CAUTION:**

Do not remove the memory card or perform any other operation (such as turning off the camcorder) during deletion. Also, be sure to use the provided AC Adapter, as the memory card may be corrupted if the battery becomes exhausted during deletion. If the memory card becomes corrupted, initialise it.

**NOTES:**

- Be sure to always use the same tape and memory card together as they were during recording; otherwise, the camcorder cannot recognise Tape and Memory Card IDs to perform Navigation Function properly.
- Check if an appropriate tape and memory card are loaded when the following messages appear: "UNABLE TO USE NAVIGATION", "THIS MEMORY CARD IS NOT COMPATIBLE".
- If you change the memory card while shooting on one tape, two memory cards will share the tape's thumbnail images. We recommend that you use one memory card for one tape.
- Navigation Search does not work if the current position is at a blank portion on the tape. Also, do not leave a blank portion partway through the tape when shooting; otherwise, Navigation Function does not work properly.
- Before shooting newly over a recorded tape, be sure to delete all thumbnail images of the previous recording from the relevant memory card.
- If you copy thumbnail images from one memory card to another via a PC, Navigation Search does not work with the copied memory card.

**Biphonic Recording (GR-DF570/470 only)**

For Biphonic Playback (☞ pg. 24), perform the following procedure.

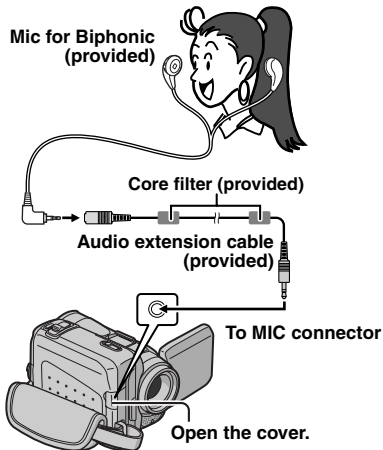

- 1** Connect the Mic for Biphonic to the MIC connector and put them on to your ears.
- 2** Perform steps **1 – 4** in "Basic Recording" (☞ pg. 19).
- 3** Set "AUX MIC" to "BIPHONIC".  
(☞ pg. 38, 40)  
● "🔊" appears on the display.
- 4** To start recording, press the Recording Start/Stop Button.

**NOTES:**

- When you put on Mic for Biphonic, never confuse left and right channel of it.
- During Biphonic recording, be sure to turn your face toward the shooting subject along with the camcorder. Otherwise the sound does not correspond with the footage.
- Some noises may be picked up when you touch the Mic for Biphonic during recording.
- Be sure to set "AUX MIC" to "OFF" when you use a microphone other than the Mic for Biphonic.

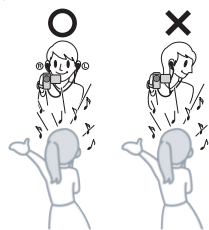

## Dubbing To Or From A VCR

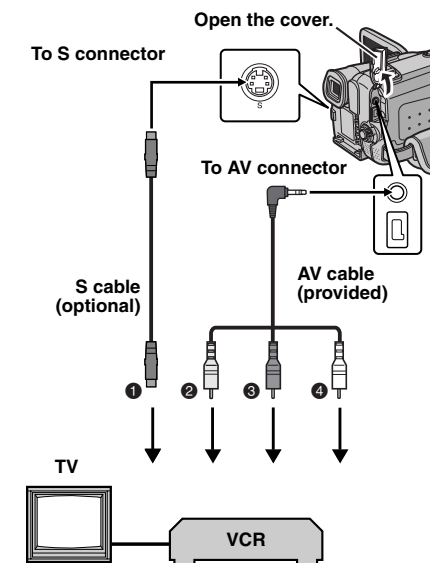

- ❶ To S-VIDEO IN or OUT\*
- ❷ Yellow to VIDEO IN or OUT
- ❸ Red to AUDIO R IN or OUT
- ❹ White to AUDIO L IN or OUT

\* Connect when your TV/VCR has an S-VIDEO IN/OUT connector. In this case, it is not necessary to connect the yellow video cable.

### NOTE:

The S-Video cable is optional. Be sure to use the YU94146A S-Video cable. Consult the JVC Service Center described on the sheet included in the package for details on its availability. Make sure to connect the end with a core filter to the camcorder. The core filter reduces interference.

### To use this camcorder as a player

- 1 Following the illustrations, connect the camcorder and the VCR's input connectors.
- 2 Start playback on the camcorder. (⇨ pg. 22)
- 3 At the point you want to start dubbing, start recording on the VCR. (Refer to the VCR's instruction manual.)
- 4 To stop dubbing, stop recording on the VCR, then stop playback on the camcorder.

### NOTES:

- It is recommended to use the AC Adapter as the power supply instead of the battery pack. (⇨ pg. 15)
- To choose whether or not the following displays appear on the connected TV
  - Date/time
    - Set "DATE/TIME" to "AUTO", "ON" or "OFF". (⇨ pg. 37, 42) Or, press **DISPLAY** on the remote control to turn on/off the date indication.
  - Time code
    - Set "TIME CODE" to "OFF" or "ON". (⇨ pg. 37, 42)
  - Indications other than date/time and time code
    - Set "ON SCREEN" to "OFF", "LCD" or "LCD/TV". (⇨ pg. 37, 42)

### To use this camcorder as a recorder

- 1 Following the illustrations, connect the camcorder and the VCR's output connectors.
- 2 Set "REC MODE" to "SP" or "LP". (⇨ pg. 38)
- 3 Set the camcorder's Power Switch to "PLAY".
- 4 Set "S/AV INPUT" to "ON". (⇨ pg. 37, 42)
- 5 Press the Recording Start/Stop Button to engage the Record-Pause mode.
  - The "AV IN" or "S IN" indication appears on the screen.
- 6 Start playback on the player.
- 7 At the point you want to start dubbing, press the Recording Start/Stop Button to start dubbing. The ⏻ indication rotates.
- 8 Press the Recording Start/Stop Button again to stop dubbing. The ⏻ indication stops rotating.
- 9 Press ■ to return to the normal playback mode.

### NOTES:

- After dubbing, set "S/AV INPUT" back to "OFF".
- Analogue signals can be converted to digital signals with this procedure.
- It is also possible to dub from another camcorder.

## Dubbing To Or From A Video Unit Equipped With A DV Connector (Digital Dubbing)

It is also possible to copy recorded scenes from the camcorder onto another video unit equipped with a DV connector. Since a digital signal is sent, there is little if any image or sound deterioration.

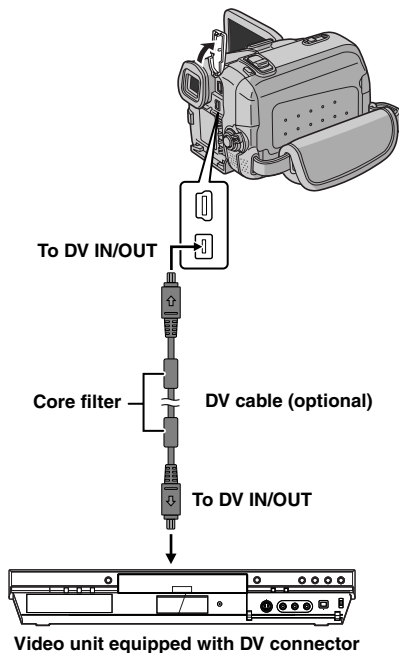



### To use this camcorder as a player

- 1 Make sure all units are turned off.
- 2 Connect this camcorder to a video unit equipped with a DV input connector using a DV cable as shown in the illustration.
- 3 Start playback on the camcorder. (➔ pg. 22)
- 4 At the point you want to start dubbing, start recording on the video unit. (Refer to the video unit's instruction manual.)
- 5 To stop dubbing, stop recording on the video unit, then stop playback on this camcorder.

### NOTES:

- It is recommended to use the AC Adapter as the power supply instead of the battery pack. (➔ pg. 15)
- If a blank portion or disturbed image is played back on the player during dubbing, the dubbing may stop so that an unusual image is not dubbed.
- Even though the DV cable is connected correctly, sometimes the image may not appear in step 4. If this occurs, turn off the power and make connections again.
- If "Playback Zoom" (➔ pg. 27) or "Playback Special Effects" (➔ pg. 27) is attempted or **SNAPSHOT** is pressed during playback, only the original playback image recorded on the tape is output from the DV IN/OUT connector.
- When using a DV cable, be sure to use the optional JVC VC-VDV204U DV cable.

### To use this camcorder as a recorder

- 1 Make sure all units are turned off.
- 2 Connect this camcorder to a video unit equipped with a DV output connector using a DV cable as shown in the illustration.
- 3 Set the camcorder's Power Switch to "PLAY".
- 4 Set "REC MODE" to "SP" or "LP". (➔ pg. 42)
- 5 Press the Recording Start/Stop Button to engage the Record-Pause mode.
  - The "DV IN" indication appears on the screen.
- 6 Start playback on the player.
- 7 At the point you want to start dubbing, press the Recording Start/Stop Button to start dubbing. The  indication rotates.
- 8 Press the Recording Start/Stop Button again to stop dubbing. The  indication stops rotating.
- 9 Press  to return to the normal playback mode.

**NOTES:**

- If no image is displayed on the LCD monitor, set "S/AV INPUT" to "OFF". (⇨ pg. 37, 42)
- Digital Dubbing is performed in the sound mode recorded on the original tape, regardless of the current "SOUND MODE" setting. (⇨ pg. 38)

**Connection To A Personal Computer**

[A] Using USB cable\* [B] Using DV cable

OR

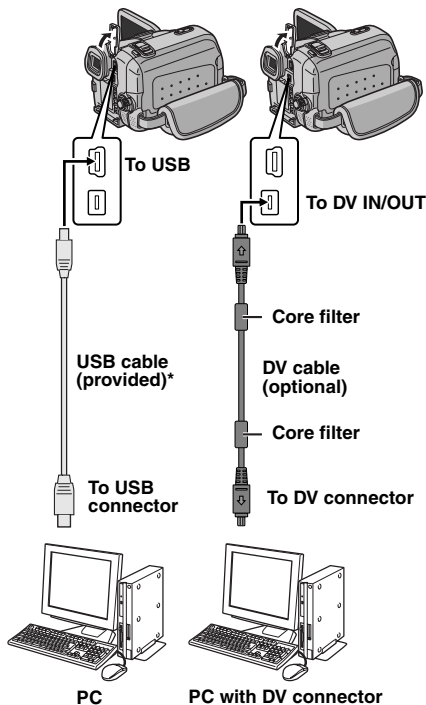

\* GR-DF570/470 only

When connecting the camcorder to a PC using a DV cable, make sure to follow the procedure below. Connecting the cable incorrectly may cause malfunctions to the camcorder and/or the PC.

- Connect the DV cable first to the PC, and then to the camcorder.
- Connect the DV cable (plugs) correctly according to the shape of the DV connector.

**[A] Using USB cable (GR-DF570/470 only)**

It is possible to do the following things:

- Transfer still images stored on a memory card to a PC.
- Transfer still/moving images recorded on a tape to a PC.

**[B] Using DV cable**

It is also possible to transfer still/moving images to a PC with a DV connector by using the provided software, software equipped with the PC or commercially available software. If you are using a Windows® XP, you can use Windows® Messenger to conduct video conferences over the Internet, using a camcorder. For details, refer to the help for the Windows® Messenger.

**NOTES:**

- Refer to "SOFTWARE INSTALLATION AND PC CONNECTION GUIDE" for the bundled software and drivers.\*
- It is recommended to use the AC Adapter as the power supply instead of the battery pack. (⇨ pg. 15)
- Never connect the USB cable and the DV cable simultaneously to the camcorder. Connect only the cable you wish to use to the camcorder.\*
- When using a DV cable, be sure to use the optional JVC VC-VDV206U or VC-VDV204U DV cable depending on the type of DV connector (4 or 6 pins) on the PC.
- If the PC connected to the camcorder via the USB cable is not powered, the camcorder does not enter the USB mode.\*
- The date/time information cannot be captured into the PC.
- Refer to the instruction manuals of the PC and Software.
- The still images can also be transferred to a PC with a DV connector-equipped capture board.

- The system may not work properly depending on the PC or capture board you are using.

**For GR-DF570/470 owners:**

“USB” appears on the LCD monitor while the PC is accessing data in the camcorder or the camcorder is transferring a file to the PC. **NEVER disconnect the USB cable while “USB” is displayed on the LCD monitor since this can result in product damage.**

\* GR-DF570/470 only

## Audio Dubbing

The audio track can be customised only when recorded in the 12-BIT and SP modes.

(☞ pg. 38)

- Use the provided remote control.

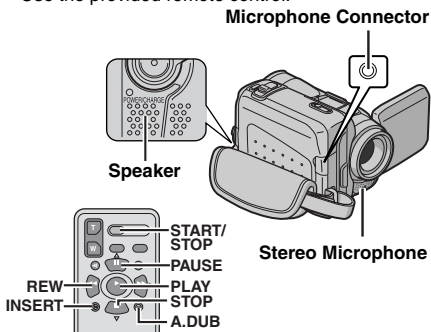

**To hear the dubbed sound during playback**  
Set “NARRATION” to “ON” or “MIX”.

(☞ pg. 37, 41)

### NOTES:

- Sound is not heard from the speaker during Audio Dubbing.
- When editing onto a tape that was recorded at 12-BIT, the old and new soundtracks are recorded separately.
- If you dub onto a blank space on the tape, the sound may be disrupted. Make sure you only edit recorded areas.
- If feedback or howling occurs during TV playback, move the camcorder’s microphone away from the TV, or turn down the TV’s volume.
- If you change from 12-BIT to 16-BIT in mid-recording and then use the tape for Audio Dubbing, it is not effective from the point where 16-BIT recording began.
- During Audio Dubbing, when the tape moves to scenes recorded in the LP mode, scenes recorded in 16-BIT audio or a blank portion, Audio Dubbing stops.
- Audio dubbing is also possible using an optional microphone connected to the MIC connector.
- While an optional microphone is connected, the built-in microphone is disabled.
- To perform Audio Dubbing with a video unit connected to the camcorder’s AV connector, first set “S/AV INPUT” to “ON” in VIDEO Menu.  
(☞ pg. 37, 42)  
The “AUX” indication appears instead of “MIC”.

**1** Play back the tape to locate the point where editing will start, then press **PAUSE (II)**.

**2** While holding **A. DUB (⊖)** on the remote control, press **PAUSE (II)**. The “**II**” and “MIC” indicators appear.

**3** Press **PLAY (▶)**, then begin “narrating”. Speak into the microphone.

- To pause dubbing, press **PAUSE (II)**.

**4** To end Audio Dubbing, press **PAUSE (II)**, then **STOP (■)**.

## Insert Editing

You can record a new scene into a previously recorded tape, replacing a section of the original recording with minimal picture distortion at the in and out points. The original audio remains unchanged.

- Use the provided remote control.

### NOTES:

- Before performing the following steps, make sure that "TIME CODE" is set to "ON". (⇨ pg. 37, 42)
- Insert Editing is not possible on a tape recorded in the LP mode or on a blank portion of a tape.

**1** Play back the tape, locate the Edit-Out point and press **PAUSE (II)**. Confirm the time code at this point. (⇨ pg. 21)

**2** Press **REW (◀◀)** until the Edit-In point is located, then press **PAUSE (II)**.

**3** Press and hold **INSERT (⊙)** on the remote control, then press **PAUSE (II)**. The "II⊙" indicator and the Time Code (min.:sec.) appear and the camcorder enters Insert-Pause mode.

**4** Press **START/STOP** to begin editing.

- Confirm the insert at the time code you checked in step **1**.
- To pause editing, press **START/STOP**. Press it again to resume editing.

**5** To end Insert Editing, press **START/STOP**, then **STOP (■)**.

### NOTES:

- Program AE with special effects (⇨ pg. 48) can be used to spice up the scenes being edited during Insert Editing.
- During Insert Editing, the date and time information changes.
- If you perform Insert Editing onto a blank space on the tape, the audio and video may be disrupted. Make sure you only edit recorded areas.
- During Insert Editing, when the tape moves to scenes recorded in the LP mode or a blank portion, Insert Editing stops. (⇨ pg. 60)



If, after following the steps in the chart below, the problem still exists, please consult your nearest JVC dealer.

The camcorder is a microcomputer-controlled device. External noise and interference (from a TV, a radio, etc.) might prevent it from functioning properly. In such cases, first disconnect its power supply unit (battery pack, AC Adapter, etc.) and wait a few minutes; and then re-connect it and proceed as usual from the beginning.

## Power

### No power is supplied.

- The power is not connected properly.
- Connect the AC Adapter securely. (⇨ pg. 15)
- The battery pack is not attached firmly.
- Detach the battery pack once again and re-attach it firmly. (⇨ pg. 13)
- The battery is dead.
- Replace the dead battery with a fully charged one. (⇨ pg. 13)

## Video and D.S.C.\* Recording

### Recording cannot be performed.

- The tape's erase protection tab is set to "SAVE".
- Set the tape's erase protection tab to "REC". (⇨ pg. 17)
- "TAPE END" appears.
- Replace with new cassette. (⇨ pg. 17)
- The cassette holder cover is open.
- Close the cassette holder cover.

### When shooting a subject illuminated by bright light, vertical lines appear.

- This is not a malfunction.

### When the screen is under direct sunlight during shooting, the screen becomes red or black for an instant.

- This is not a malfunction.

### During recording, the date/ time does not appear.

- "DATE/TIME" is set to "OFF".
- Set "DATE/TIME" to "ON". (⇨ pg. 37, 40)

### The LCD monitor or viewfinder indications blink.

- Certain Wipe/Fader effects, certain modes of Program AE with special effects, "DIS" and other functions that cannot be used together are selected at the same time.
- Re-read the sections covering Wipe/Fader effects, Program AE with special effects and "DIS". (⇨ pg. 37, 39, 48)

### Digital Zoom does not work.

- 15X optical zoom is selected.
- Set "ZOOM" to "60X" or "700X". (⇨ pg. 38)
- The VIDEO/MEMORY Switch is set to "MEMORY".\*
- Set the VIDEO/MEMORY Switch to "VIDEO".

## Video and D.S.C.\* Playback

### The tape is moving, but there is no picture.

- Your TV has AV input terminals, but is not set to its VIDEO mode.
- Set the TV to the mode or channel appropriate for video playback. (⇨ pg. 23)
- The cassette holder cover is open.
- Close the cassette holder cover. (⇨ pg. 17)

### Blocks of noise appear during playback, or there is no playback picture and the screen becomes blue.

- Clean the video heads with an optional cleaning cassette. (⇨ pg. 64)

## Advanced features

### The focus does not adjust automatically.

- Focus is set to the Manual mode.
- Set Focus to the Auto mode. (⇨ pg. 45)
- The lens is dirty or covered with condensation.
- Clean the lens and check the focus again. (⇨ pg. 61)

### In the 5-Second mode, recording ends before 5 seconds have elapsed.

- The 5-Second mode is set to "Anim." in MANUAL Menu.
- Set "5S" to "5S" in MANUAL Menu. (⇨ pg. 37, 43)

### Snapshot mode cannot be used.

- The Squeeze mode (SQUEEZE) is selected.
- Disengage the Squeeze (SQUEEZE) mode. (⇨ pg. 37, 39)

\* GR-DF570/470 only

**The colour of Snapshot looks strange.**

- The light source or the subject does not include white. Or there are various different light sources behind the subject.
- Find a white subject and compose your shot so that it also appears in the frame. (⇨ pg. 28, 44)

**The image taken using Snapshot is too dark.**

- Shooting was performed under backlit conditions.
- Press **BACK LIGHT**. (⇨ pg. 46)

**The image taken using Snapshot is too bright.**

- The subject is too bright.
- Set "☀" to "SPOTLIGHT". (⇨ pg. 49)

**White Balance cannot be activated.**

- The Sepia (SEPIA) or Monotone (MONOTONE) mode is activated.
- Disengage the Sepia (SEPIA) or Monotone (MONOTONE) mode before setting White Balance. (⇨ pg. 49)

**The Black & White Fader does not work.**

- The Sepia (SEPIA) or Monotone (MONOTONE) mode is activated.
- Disengage the Sepia (SEPIA) and Monotone (MONOTONE). (⇨ pg. 49)

**The image looks like the shutter speed is too slow.**

- When shooting in the dark, the unit becomes highly sensitive to light when "GAIN UP" is set to "AUTO".
- If you want the lighting to look more natural, set "GAIN UP" to "AGC" or "OFF". (⇨ pg. 37, 38)

**Other problems****The POWER/CHARGE lamp on the camcorder does not light during charging.**

- Charging is difficult in places subject to extremely high/low temperatures.
- To protect the battery, it is recommended to charge it in places with a temperature of 10°C to 35°C. (⇨ pg. 62)
- The battery pack is not attached firmly.
- Detach the battery pack once again and re-attach it firmly. (⇨ pg. 13)

**"SET DATE/TIME!" appears.**

- The date/time is not set.
- Set the date/time. (⇨ pg. 16)
- The built-in clock battery has run out and the previously set date/time has been erased.
- Consult your nearest JVC dealer for replacement.

**Files stored in the memory card cannot be deleted. (GR-DF570/470 only)**

- Files stored in the memory card are protected.
- Remove protection from the files stored in the memory card and delete them. (⇨ pg. 33)

**When the image is printed from the printer, a black bar appears at the bottom of the screen.**

- This is not a malfunction.
- By recording with "DIS" activated (⇨ pg. 37, 39) this can be avoided.

**When the camcorder is connected via the DV connector, the camcorder does not operate.**

- The DV cable was plugged/unplugged with power turned on.
- Turn the camcorder's power off and on again, then operate it.

**Images on the LCD monitor appear dark or whitish.**

- In places subject to low temperature, images become dark due to the characteristics of the LCD monitor. This is not a malfunction.
- Adjust the brightness and angle of the LCD monitor. (⇨ pg. 17, 19)
- When the LCD monitor's fluorescent light reaches the end of its service life, images on the LCD monitor become dark.
- Consult your nearest JVC dealer.

**Coloured bright spots appear all over the LCD monitor or the viewfinder.**

- The LCD monitor and the viewfinder are made with high-precision technology. However, black spots or bright spots of light (red, green or blue) may appear constantly on the LCD monitor or the viewfinder. These spots are not recorded on the tape. This is not due to any defect of the unit. (Effective dots: more than 99.99%)

**The cassette will not load properly.**

- The battery's charge is low.
- Install a fully charged battery. (⇨ pg. 13)

**The memory card cannot be removed from the camcorder. (GR-DF570/470 only)**

- Push in the memory card a few more times. (⇨ pg. 18)

**Picture does not appear on the LCD monitor.**

- The viewfinder is pulled out and "PRIORITY" is set to "FINDER".
- Push the viewfinder back in or set "PRIORITY" to "LCD". (⇨ pg. 19, 37, 40)
- The LCD monitor's brightness setting is too dark.
- Adjust the brightness of the LCD monitor. (⇨ pg. 17)
- If the monitor is tilted upward 180 degrees, open the monitor fully. (⇨ pg. 19)

**An error indication (01 – 04 or 06) appears.**

- A malfunction of some kind has occurred. In this case the camcorder's functions become unusable.
- ⇨ pg. 61.

**The remote control does not work.**

- "REMOTE" is set to "OFF".
- Set "REMOTE" to "ON". (⇨ pg. 37, 40)
- The remote control does not point at the remote sensor.
- Point at the remote sensor. (⇨ pg. 25)
- The remote control batteries are exhausted.
- Replace the batteries with fresh ones. (⇨ pg. 25)

**Warning Indications**

Displays the battery remaining power.

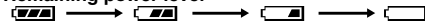
**Remaining power level**

High

Exhausted

As the battery power comes close to nil, the battery remaining power indicator blinks. When the battery power is exhausted, power turns off automatically.



Appears when no tape is loaded. (⇨ pg. 17)

**CHECK TAPE'S ERASE PROTECTION TAB**

Appears when the erase protection tab is set to "SAVE" while the Power Switch is set to "A" or "M" and the VIDEO/MEMORY Switch is set to "VIDEO"\*. (⇨ pg. 15)

**⊗ USE CLEANING CASSETTE**

Appears if dirt is detected on the heads during recording. Use an optional cleaning cassette. (⇨ pg. 63)

**⏸ CONDENSATION, OPERATION PAUSED PLEASE WAIT**

Appears if condensation occurs. When this indication is displayed, wait more than 1 hour until condensation disappears.

**TAPE!**

Appears if a tape is not loaded when the Recording Start/Stop Button or **SNAPSHOT** Button is pressed while the Power Switch is set to "A" or "M" and the VIDEO/MEMORY Switch is set to "VIDEO"\*. REFERENCES

**TAPE END**

Appears when the tape ends during recording or playback.

**SET DATE/TIME!**

- Appears when the date/time is not set. (⇨ pg. 16)
- The built-in clock battery has run out and the previously set date/time has been erased. Consult your nearest JVC dealer for replacement.

\* GR-DF570/470 only

**LENS CAP**

Appears for 5 seconds after power is turned on if the lens cap is attached or when it is dark.

**A. DUB ERROR!**

Appears if Audio Dubbing is attempted on a blank portion of a tape. (☞ pg. 55)

**A. DUB ERROR!**

**<CANNOT DUB ON A LP RECORDED TAPE>**  
**<CANNOT DUB ON A 16BIT RECORDING>**  
**<CHECK TAPE'S ERASE PROTECTION TAB>**

- Appears if Audio Dubbing is attempted on a tape recorded in the LP mode. (☞ pg. 55)
- Appears if Audio Dubbing is attempted on a tape recorded in 16-BIT audio. (☞ pg. 55)
- Appears if **A. DUB** (⊖) on the remote control is pressed when the erase protection tab is set to "SAVE". (☞ pg. 55)

**INSERT ERROR!**

Appears if Insert Editing is attempted on a blank portion of a tape. (☞ pg. 56)

**INSERT ERROR!**

**<CANNOT EDIT ON A BLANK PORTION>**  
**<CANNOT EDIT ON A LP RECORDED TAPE>**  
**<CHECK TAPE'S ERASE PROTECTION TAB>**

- Appears if Insert Editing is attempted on a blank portion of a tape.
- Appears if Insert Editing is attempted on a tape recorded in the LP mode. (☞ pg. 56)
- Appears if **INSERT** (Ⓢ) on the remote control is pressed when the erase protection tab is set to "SAVE". (☞ pg. 56)

**MEMORY IS FULL\***

Appears when the memory card's memory is full and shooting is not possible.

**HDV **

Appears when pictures recorded in the HDV format are not detected. The pictures in the HDV format cannot be played back with this camcorder.

**?**

Appears when playing back a file that is not compatible with DCF or a file with a size that is not compatible with this camcorder.

**COPYING FAILED**

- Appears if dubbing of copyguarded signals is attempted while this camcorder is being used as a recorder.
- Appears in the following cases when dubbing from a tape to a memory card\*:
  - when no memory card is loaded.
  - when the memory card's memory is full.
  - when the memory card is not formatted.
  - when a write-protected SD Memory Card is loaded. (☞ pg. 33)

**MEMORY CARD!\***

Appears if there is no memory card loaded when you attempt to record on a memory card or access data on a memory card.

**PLEASE FORMAT\***

Appears when there is a problem with a memory card and its memory is corrupt, or it has not been initialised. Initialise the memory card. (☞ pg. 36)

**NO IMAGES STORED\***

Appears if there are no image files stored in the memory card when you attempt memory card playback.

**NO E-MAIL CLIP STORED\***

Appears if there are no video clip files stored in the memory card when you attempt memory card playback.

**CARD ERROR!\***

Appears when the camcorder does not recognise the loaded memory card. Remove the memory card once and insert it again. Repeat these procedures until no indication appears. If the indication still appears, the memory card is corrupted.

**CHECK CARD'S WRITE PROTECTION SWITCH\***

- Appears when you attempt to shoot digital still images when the write protection tab on the SD Memory Card is set to the "LOCK" position.
- Appears when you attempt MEMORY SELECT menu operation with a write-protected SD Memory Card loaded.

**UNIT IN SAFEGUARD MODE REMOVE AND REATTACH BATTERY**

The error indications (01, 02 or 06) show what type of malfunction has occurred. When an error indication appears, the camcorder turns off automatically. Remove the power supply (battery, etc.) and wait a few minutes for the indication to clear. When it does, you can resume using the camcorder. If the indication remains, consult your nearest JVC dealer.

**UNIT IN SAFEGUARD MODE EJECT AND REINSERT TAPE**

The error indications (03 or 04) show what type of malfunction has occurred. When an error indication appears, the camcorder turns off automatically. Eject the cassette once and re-insert it, then check if the indication clears. When it does, you can resume using the camcorder. If the indication remains, consult your nearest JVC dealer.

\* GR-DF570/470 only

**Cleaning The Camcorder**

Before cleaning, turn off the camcorder and remove the battery pack and AC Adapter.

**To clean the exterior**

Wipe gently with a soft cloth. Put the cloth in diluted mild soap and wring it well to wipe off heavy dirt. Then wipe again with a dry cloth.

**To clean the LCD monitor**

Wipe gently with a soft cloth. Be careful not to damage the monitor. Close the LCD monitor.

**To clean the lens**

Blow it with a blower brush, then wipe gently with lens cleaning paper.

**NOTES:**

- Avoid using strong cleaning agents such as benzine or alcohol.
- Cleaning should be done only after the battery pack has been removed or other power units have been disconnected.
- Mould may form if the lens is left dirty.
- When using a cleaner or chemically treated cloth refer to the cautions of each product.
- To clean the viewfinder, please consult your nearest JVC dealer.

## Battery Packs

The supplied battery pack is a lithium-ion battery. Before using the supplied battery pack or an optional battery pack, be sure to read the following cautions:

### ● To avoid hazards

- ... do not burn.
- ... do not short-circuit the terminals. When transporting, make sure the provided battery cap is attached to the battery. If the battery cap is misplaced, carry the battery in a plastic bag.
- ... do not modify or disassemble.
- ... do not expose the battery to temperatures exceeding 60°C, as this may cause the battery to overheat, explode or catch fire.
- ... use only specified chargers.

### ● To prevent damage and prolong service life

- ... do not subject to unnecessary shock.
- ... charge in an environment where temperatures are within the tolerances shown in the chart below. This is a chemical reaction type battery — cooler temperatures impede chemical reaction, while warmer temperatures can prevent complete charging.
- ... store in a cool, dry place. Extended exposure to high temperatures will increase natural discharge and shorten service life.
- ... fully charge and then fully discharge the battery every 6 months when storing the battery pack over a long period time.
- ... remove from charger or powered unit when not in use, as some machines use current even when switched off.

### Terminals

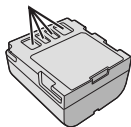

## NOTES:

- It is normal for the battery pack to be warm after charging, or after use.
- Temperature Range Specifications**
- Charging: 10°C to 35°C
  - Operation: 0°C to 40°C
  - Storage: -20°C to 50°C
- The lower the temperature, the longer recharging takes.
  - Charging times are for a fully discharged battery pack.

## Cassettes

To properly use and store your cassettes, be sure to read the following cautions:

### ● During use

- ... make sure the cassette bears the Mini DV mark.
- ... be aware that recording onto prerecorded tapes automatically erases the previously recorded video and audio signals.
- ... make sure the cassette is positioned properly when inserting.
- ... do not load and unload the cassette repeatedly without allowing the tape to run at all. This slackens the tape and can result in damage.
- ... do not open the front tape cover. This exposes the tape to fingerprints and dust.

### ● Store cassettes

- ... away from heaters or other heat sources.
- ... out of direct sunlight.
- ... where they won't be subject to unnecessary shock or vibration.
- ... where they won't be exposed to strong magnetic fields (such as those generated by motors, transformers or magnets).
- ... vertically, in their original cases.

### The Benefits Of Lithium-Ion Batteries

Lithium-ion battery packs are small but have a large power capacity. However, when one is exposed to cold temperatures (below 10°C), its usage time becomes shorter and it may cease to function. If this happens, place the battery pack in your pocket or other warm, protected place for a short time, then re-attach it to the camcorder.

## Memory Cards (GR-DF570/470 only)

To properly use and store your memory cards, be sure to read the following cautions:

### • During use

- ... make sure the memory card bears the SD or MultiMediaCard mark.
- ... make sure the memory card is positioned properly when inserting.

### • While the memory card is being accessed (during recording, playback, deletion, initialisation, etc.)

- ... never unload the memory card and never turn off the camcorder.

### • Store memory cards

- ... away from heaters or other heat sources.
- ... out of direct sunlight.
- ... where they won't be subject to unnecessary shock or vibration.
- ... where they won't be exposed to strong magnetic fields (such as those generated by motors, transformers or magnets).

## LCD Monitor

### • To prevent damage to the LCD monitor, DO NOT

- ... push it strongly or apply any shocks.
- ... place the camcorder with the LCD monitor on the bottom.

### • To prolong service life

- ... avoid rubbing it with coarse cloth.

### • Be aware of the following phenomena for LCD monitor use. These are not malfunctions

- ... While using the camcorder, the surface around the LCD monitor and/or the back of the LCD monitor may heat up.
- ... If you leave power on for a long time, the surface around the LCD monitor becomes hot.

## Main Unit

### • For safety, DO NOT

- ... open the camcorder's chassis.
- ... disassemble or modify the unit.
- ... short-circuit the terminals of the battery pack. Keep it away from metallic objects when not in use.
- ... allow inflammables, water or metallic objects to enter the unit.
- ... remove the battery pack or disconnect the power supply while the power is on.
- ... leave the battery pack attached when the camcorder is not in use.

### • Avoid using the unit

- ... in places subject to excessive humidity or dust.
- ... in places subject to soot or steam such as near a cooking stove.
- ... in places subject to excessive shock or vibration.
- ... near a television set.
- ... near appliances generating strong magnetic or electric fields (speakers, broadcasting antennas, etc.).
- ... in places subject to extremely high (over 40°C) or extremely low (under 0°C) temperatures.

### • DO NOT leave the unit

- ... in places of over 50°C.
- ... in places where humidity is extremely low (below 35%) or extremely high (above 80%).
- ... in direct sunlight.
- ... in a closed car in summer.
- ... near a heater.

### • To protect the unit, DO NOT

- ... allow it to become wet.
- ... drop the unit or strike it against hard objects.
- ... subject it to shock or excessive vibration during transportation.
- ... keep the lens directed at extremely bright objects for long periods.
- ... expose the lens and viewfinder's lens to direct sunlight.
- ... carry it by holding the LCD monitor or the viewfinder.
- ... swing it excessively when using the hand strap or the grip.
- ... swing the soft camera case excessively when the camcorder is inside it.

- Dirty heads can cause the following problems:



...No picture during playback.  
 ...Blocks of noise appear during playback.  
 ...During recording or playback, the Head Clog Warning indicator "⊗" appears.  
 ...Recording cannot be performed properly.  
 In such cases, use an optional cleaning cassette. Insert it and play back. If the cassette is used more than once consecutively, damage to the video heads may result. After the camcorder plays back for about 20 seconds, it stops automatically. Also refer to the cleaning cassette's instructions.

If, after using the cleaning cassette, the problems still exist, consult your nearest JVC dealer.

Mechanical moving parts used to move the video heads and video tape tend to become dirty and worn out over time. In order to maintain a clear picture at all times, periodic check-ups are recommended after using the unit for about 1,000 hours. For periodic check-ups please consult your nearest JVC dealer.

## How To Handle A CD-ROM (GR-DF570/470 only)

- Take care not to soil or scratch the mirror surface (opposite to the printed surface). Do not write anything or put a sticker on either the front or back surface. If the CD-ROM gets dirty, gently wipe it with a soft cloth outward from the centre hole.
- Do not use conventional disc cleaners or cleaning spray.
- Do not bend the CD-ROM or touch its mirror surface.
- Do not store your CD-ROM in a dusty, hot or humid environment. Keep it away from direct sunlight.

### About moisture condensation

- You have observed that pouring a cold liquid into a glass will cause drops of water to form on the glass' outer surface. This same phenomenon occurs on the head drum of a camcorder when it is moved from a cool place to a warm place, after heating a cold room, under extremely humid conditions or in a place directly subjected to the cool air from an air conditioner.
- Moisture on the head drum can cause severe damage to the video tape, and can lead to internal damage to the camcorder itself.

### Serious malfunctioning

If malfunctioning occurs, stop using the unit immediately and consult your local JVC dealer.

The camcorder is a microcomputer-controlled device. External noise and interference (from a TV, a radio, etc.) might prevent it from functioning properly. In such cases, first disconnect its power supply unit (battery pack, AC Adapter, etc.) and wait a few minutes and then re-connect it and proceed as usual from the beginning.



## Camcorder

### For General

#### Power supply

DC 11 V (Using AC Adapter)  
DC 7.2 V (Using battery pack)

#### Power consumption

For GR-DF570:

Approx. 3.7 W (4 W\*) (LCD monitor off, viewfinder on)  
Approx. 4.7 W (5 W\*) (LCD monitor on, viewfinder off)

For GR-DF470/430:

Approx. 3.2 W (3.5 W\*) (LCD monitor off, viewfinder on)  
Approx. 4.2 W (4.5 W\*) (LCD monitor on, viewfinder off)

\* Using LED Light

#### Dimensions (W x H x D)

75 mm x 74 mm x 111 mm (with the LCD monitor closed and the viewfinder pushed back in)

#### Weight

Approx. 410 g (400 g\*\*) (without battery, cassette, memory card and lens cap)

Approx. 490 g (480 g\*\*) (incl. battery, cassette, memory card and lens cap)

#### Operating temperature

0°C to 40°C

#### Operating humidity

35% to 80%

#### Storage temperature

-20°C to 50°C

#### Pickup

1/4.5" (1/6\*\*\*) CCD

#### Lens

F 1.2, f = 3.0 mm to 45 mm (2.6 mm to 39 mm\*\*),  
15:1 power zoom lens

#### Filter diameter

ø30.5 mm

#### LCD monitor

2.5" diagonally measured, LCD panel/TFT active matrix system

#### Viewfinder

Electronic viewfinder with 0.16" colour LCD

#### Speaker

Monaural

#### LED Light

Effective distance: 1.5 m

\*\* GR-DF470/430 only

### For Digital Video Camera

#### Format

DV format (SD mode)

#### Signal format

PAL standard

#### Recording/Playback format

Video: Digital component recording

Audio: PCM digital recording, 32 kHz 4-channel (12-BIT), 48 kHz 2-channel (16-BIT)

#### Cassette

Mini DV cassette

#### Tape speed

SP: 18.8 mm/s, LP: 12.5 mm/s

#### Maximum recording time (using 80 min. cassette)

SP: 80 min., LP: 120 min.

### For Digital Still Camera (GR-DF570/470 only)

#### Storage media

SD Memory Card/MultiMediaCard

#### Compression system

JPEG (compatible)

#### File size

Still image:

4 modes (1600 x 1200 pixels\*/1152 x 864 pixels\*/  
1024 x 768 pixels/640 x 480 pixels)

Moving image:

1 mode (160 x 120 pixels)

#### Picture quality

2 modes (FINE/STANDARD)

#### Approximate number of storable images

☞ pg. 28

\* GR-DF570 only

### For Connectors

#### S

S-Video input:

Y: 0.8 V to 1.2 V (p-p), 75 Ω, analogue

C: 0.2 V to 0.4 V (p-p), 75 Ω, analogue

S-Video output:

Y: 1.0 V (p-p), 75 Ω, analogue

C: 0.29 V (p-p), 75 Ω, analogue

#### AV

Video input: 0.8 V to 1.2 V (p-p), 75 Ω, analogue

Video output: 1.0 V (p-p), 75 Ω, analogue

Audio input: 300 mV (rms), 50 kΩ, analogue, stereo

Audio output: 300 mV (rms), 1 kΩ, analogue, stereo

#### Microphone input

ø3.5 mm, stereo

#### DV

Input/output: 4-pin, IEEE1394 compliant

#### USB (GR-DF570/470 only)

Mini USB-B type, USB 1.1/2.0\* compliant

\* Supports at the maximum of Full-Speed (12 Mbps) when using USB Mass Storage Class driver.

## AC Adapter

#### Power requirement

AC 110 V to 240 V~, 50 Hz/60 Hz

#### Output

DC 11 V , 1 A

Specifications shown are for SP mode unless otherwise indicated. E & O.E. Design and specifications subject to change without notice.

<b>A</b>		<b>P</b>	
AC Adapter .....	15	Picture Quality .....	41
Animation .....	39	Playback Sound .....	41
Audio Dubbing .....	55	Playback Special Effects .....	27
<b>B</b>		Power-Linked Operation .....	15
Backlight Compensation .....	46	Program AE With Special Effects .....	48
Battery Pack .....	13, 15, 62	<b>Q</b>	
Beep .....	39	Quick Review .....	21
Biphonic .....	24, 51	<b>R</b>	
Blank Search .....	22	Recording Capacity	
<b>C</b>		Memory Card .....	28, 32
Changing The Menu Settings .....	37 – 42	Tape .....	19
Charging The Battery Pack .....	13	Recording Media Selection .....	41
Connection To A Personal Computer .....	54	Remote Control .....	25
Connections To A TV Or VCR .....	23	Resetting The File Name .....	33
<b>D</b>		<b>S</b>	
Data Battery .....	14	Self Recording .....	20
Date/Time Settings .....	16	Slow-Motion Playback .....	26
Deleting Files .....	34	Snapshot Mode .....	38
Demonstration Mode .....	40	Sound Mode .....	38, 41
Digital Image Stabilisation (DIS) .....	39	Speaker Volume .....	22
DPOF Setting (Digital Print Order Format)		Specifications .....	65
.....	35, 36	Spot Exposure Control .....	46
Dubbing .....	33, 52, 53	<b>T</b>	
<b>E</b>		Tape Speed (REC MODE) .....	38, 42
E-Mail Clip Recording .....	32	Telephoto Setting .....	39
Exposure Control .....	45	Time Code .....	21, 40
<b>I</b>		Tripod Mounting .....	17
Image Size .....	41	Troubleshooting .....	57
Initialising A Memory Card .....	36	<b>W</b>	
Insert Editing .....	56	Warning Indications .....	59
Iris Lock .....	46	White Balance .....	47
<b>L</b>		Wide Mode .....	39
LCD Monitor and Viewfinder .....	16, 19	Wipe Or Fader Effects .....	48
LED Light .....	43	<b>Z</b>	
Live Slow .....	43	Zooming .....	20, 27, 38
Loading A Cassette .....	17	5-Second Recording .....	43
Loading A Memory Card .....	18		
<b>M</b>			
Manual Focus .....	45		
Memory Card .....	18, 63		
Motor Drive Mode .....	44		
<b>N</b>			
Navigation .....	38, 49		
Night-Alive .....	44		

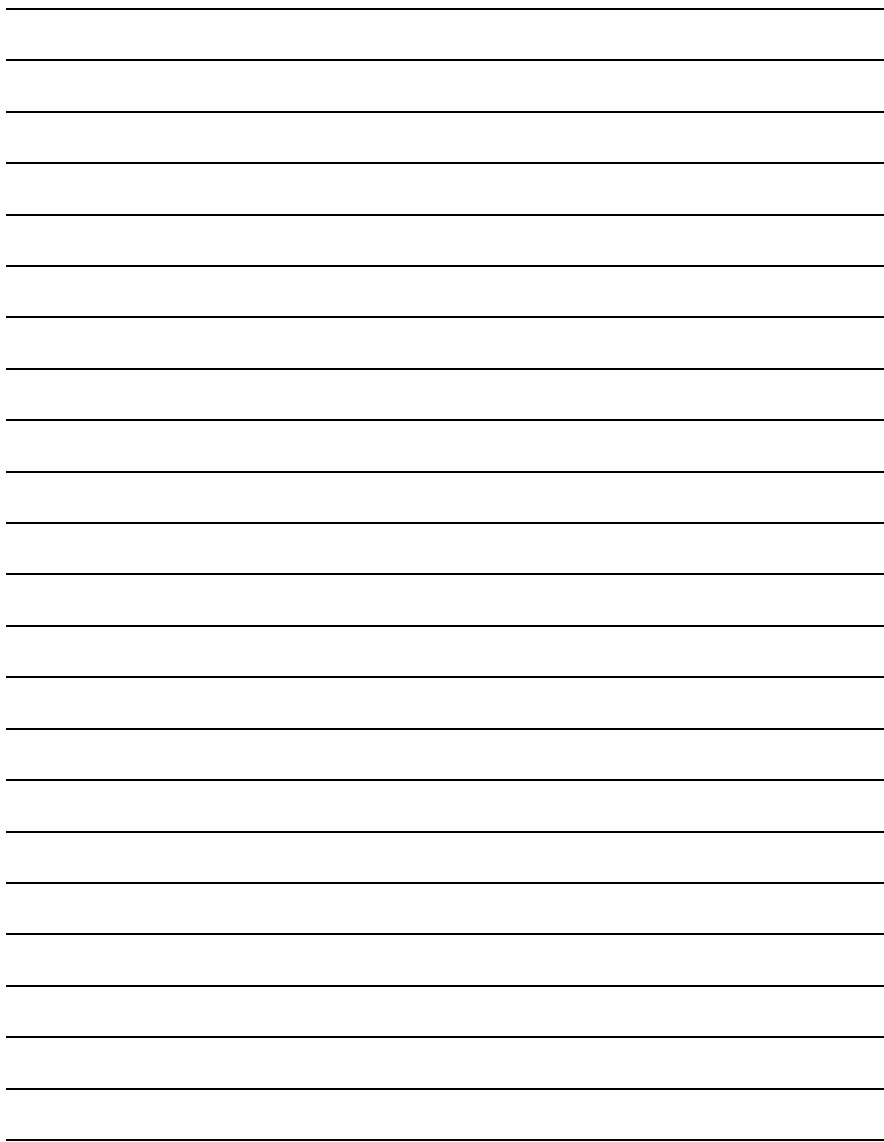

**EN**

**GR-DF570**  
**GR-DF470**  
**GR-DF430**

---

**JVC**

**JVC****SOFTWARE INSTALLATION  
AND PC CONNECTION GUIDE**

LYT1387-001A

© 2004 Victor Company of Japan, Limited

Printed in Malaysia

1104MKH-ID-VM

M5D7/D5/D2 DSC VC

**JVC SOFTWARE LICENSE  
AGREEMENT****IMPORTANT**

**TO CUSTOMERS: PLEASE MAKE SURE TO READ THIS CAREFULLY BEFORE INSTALLING OR USING THE SOFTWARE PROGRAM NAMED "DIGITAL PHOTO NAVIGATOR" ("Program") ON YOUR PC.**

The right to use the Program is granted by Victor Company of Japan, Limited ("JVC") to You only on the condition that You agree to the following.

Should You not agree to the terms hereof, You may not install or use the Program. HOWEVER, INSTALLING OR USING THE PROGRAM INDICATES YOUR ACCEPTANCE OF THESE TERMS AND CONDITIONS.

**1 COPYRIGHT; OWNERSHIP**

You acknowledge that all copyrights and other intellectual property rights in the Program are owned by JVC and its licensor, and remain vested in JVC and such licensor. The Program is protected under the copyright law of Japan and other countries, and related Conventions.

**2 GRANT OF LICENSE**

- (1) Subject to the conditions of this Agreement, JVC grants to You a non-exclusive right to use the Program. You may install and use the Program

on a HDD or other storage devices incorporated in Your PC.

- (2) You may make one (1) copy of the Program solely for your personal backup or archival purposes.

**3 RESTRICTION ON THE PROGRAM**

- (1) You may not reverse engineer, decompile, disassemble, revise or modify the Program, except to the extent that expressly permitted by applicable law.
- (2) You may not copy or use the Program, in whole or in part, other than as expressly specified in this Agreement.
- (3) You have no right to grant a license to use the Program, and may not distribute, rent, lease or transfer the Program to any third party or otherwise let them use the Program.

**4 LIMITED WARRANTY**

JVC warrants that any media in which the Program is embodied are free from any defects in materials and workmanship for a period of thirty (30) days from the date of Your purchasing any our products accompanying the Program. JVC's entire liability and your exclusive remedy in connection with the Program shall be replacement of such defective media. EXCEPT FOR THE EXPRESS WARRANTIES STATED HEREIN AND TO THE EXTENT PERMITTED BY APPLICABLE LAW, JVC AND ITS LICENSORS DISCLAIM

**CONTINUED ON NEXT PAGE**

ANY OTHER WARRANTIES, EITHER EXPRESS OR IMPLIED, INCLUDING BUT NOT LIMITED TO IMPLIED WARRANTIES OF MERCHANTABILITY AND FITNESS FOR A PARTICULAR PURPOSE IN REGARD TO THE PROGRAM AND THE ACCOMPANYING PRINTED MATERIALS. SHOULD THERE BE ANY PROBLEM ARISING FROM OR CAUSED BY THE PROGRAM, YOU SHOULD SETTLE ALL SUCH PROBLEM AT YOUR OWN COST AND EXPENSE.

## **5 LIMITED LIABILITY**

TO THE EXTENT PERMITTED BY APPLICABLE LAW, IN NO EVENT SHALL JVC AND ITS LICENSORS BE LIABLE FOR ANY INDIRECT, SPECIAL, INCIDENTAL OR CONSEQUENTIAL DAMAGES WHATSOEVER, REGARDLESS OF THE FORM OF ACTION WHETHER IN CONTRACT, TORT OR OTHERWISE ARISING OUT OF OR IN CONNECTION WITH THE USE OF OR INABILITY TO USE THE PROGRAM, EVEN IF JVC HAS BEEN ADVISED OF THE POSSIBILITY OF SUCH DAMAGES. YOU WILL INDEMNIFY AND HOLD HARMLESS JVC FROM ANY LOSS, LIABILITY OR COST ARISING OUT OF OR IN ANY WAY CONNECTED TO CLAIMS FROM ANY THIRD PARTY RELATING TO THE USE OF THE PROGRAM.

## **6 TERM**

This Agreement will become effective on the date when You install and use the Program on Your machine, and continue to be in effect until the termination under the following provision.

Should You breach any provision of this Agreement, JVC may terminate this Agreement without giving any notice to You. In this event, JVC may claim against You for any damages caused by Your breach. Should this Agreement be terminated, You must immediately destroy the Program stored in Your machine (including the erasing from any

memory in Your PC), and no longer own such Program.

## **7 EXPORT CONTROL**

You agree that You will not ship, transfer or export the Program or underlying information and technology to any countries to which Japan and other relevant countries have initiated an embargo on such goods.

## **8 U.S. GOVERNMENT USER**

If You are an agency of the United States of America (the "Government"), You acknowledge JVC's representation that the Program is a "Commercial Item" as defined in Federal Acquisition Regulation (FAR) part 2.101 (g) consisting unpublished "Commercial Computer Software" as those items are used at FAR part 12.212 and is only licensed to You with the same use rights JVC grants all commercial end users pursuant to the terms of this Agreement.

## **9 GENERAL**

- (1) No modification, change, addition, deletion or other alternation of or to this Agreement will be valid unless reduced to writing and signed by an authorized representative of JVC.
- (2) If any part of this Agreement is held invalid by or in conflict with any law having jurisdiction over this Agreement, the remaining provisions will remain in full force and effect.
- (3) This Agreement shall be governed by and interpreted under the laws of Japan. The Tokyo District Court has jurisdiction over all disputes which may arise with respect to the execution, interpretation and performance of this Agreement.

Victor Company of Japan, Limited

### **NOTE:**

If You acquired the Program in Germany, the provisions of Sections 4 (Limited Warranty) and 5 (Limited Liability) provided above will be replaced with those of the German version of this Agreement.

**CAUTION:**

- Operate this equipment according to the operating procedures described in this manual.
- Use only the provided CD-ROM. Never use any other CD-ROM to run this software.
- Do not attempt to modify this software.
- Changes or modifications not approved by JVC could void user's authority to operate the equipment.

**How to handle a CD-ROM**

- Take care not to soil or scratch the mirror surface (opposite to the printed surface). Do not write anything or put a sticker on either the front or back surface. If the CD-ROM gets dirty, gently wipe it with a soft cloth outward from the center hole.
- Do not use conventional disc cleaners or cleaning spray.
- Do not bend the CD-ROM or touch its mirror surface.
- Do not store your CD-ROM in a dusty, hot or humid environment. Keep it away from direct sunlight.

You can find the latest information (in English) on the provided software program at our world wide web server at <http://www.jvc-victor.co.jp/english/index-e.html>

**Notice for Users**

Use of this software is authorized according to the terms of the software license. When contacting the nearest JVC office or agency in your country about this software (refer to the JVC Worldwide Service Network at <http://www.jvc-victor.co.jp/english/worldmap/index-e.html>), please fill out the following and have the appropriate information ready.

Product Name		
Model		
Problem		
Error Message		
PC	Manufacturer	
	Model	<input type="checkbox"/> Desktop <input type="checkbox"/> Laptop
	CPU	
	OS	
	Memory	MB
	Available Hard Disk Space	MB

Please note that it may take some time to respond to your questions, depending on their subject matter.

**JVC cannot answer questions regarding basic operation of your PC, or questions regarding specifications or performance of the OS, other applications or drivers.**

**CyberLink**

For details of CyberLink's technical support service, refer to the "Readme" of each software (pg. 15) and the following website: <http://www2.cli.co.jp/products/dvc/>

# System Requirements

## ■ Windows®

The following requirements must be satisfied to connect a camcorder to a PC and to use Digital Photo Navigator.

**OS:** Windows® 98 Second Edition (98SE) (pre-installed), Windows® Millennium Edition (Me) (pre-installed), Windows® 2000 Professional (2000) (pre-installed), Windows® XP Home Edition (XP) (pre-installed), or Windows® XP Professional (XP) (pre-installed)

**CPU:** Intel MMX™ Pentium®, at least 200 MHz

**RAM:** At least 64 MB

**Free hard disk space:** At least 10 MB for installation, at least 500 MB recommended

**Connector:** USB connector

**Display:** Must be capable of displaying 800 x 600 dots with 16-bit color

**Miscellaneous:** Internet Explorer 5.5 or later

## For CyberLink DVD Solution

In addition to the requirements above, the following requirements must be satisfied to use CyberLink DVD Solution.

**OS:** The same as requirements above.

For capturing DV pictures with USB connection (USB 2.0), Windows® XP which is pre-installed or updated to Windows® XP Service Pack 2\* is necessary.

\* To update to Windows® XP Service Pack 2, click [Start], and select [Windows Update] in [All Programs]. For details, refer to the Windows® XP help or the Microsoft's web site: <http://www.microsoft.com/>

**CPU:** Intel Pentium® III, at least 700 MHz, Intel Pentium® 4, at least 2.2 GHz recommended

**RAM:** At least 128 MB, at least 256 MB DDR recommended

**Free hard disk space:** At least 300 MB for installation, at least 10 GB for creating DVD video, at least 1 GB for creating VCD

**Connector:** USB 2.0 connector or IEEE1394 (i.LINK) connector.

For capturing DV pictures with USB connection, Windows® XP equipped with USB 2.0 connector is necessary.

**Miscellaneous:** DirectX 9.0a or later (DirectX 9.0 is installed automatically)

**Supported media:**

DVD-Video: DVD-R/-RW, DVD+R/+RW, DVD+R DL

DVD-VR: DVD-RW, DVD+RW, DVD-RAM

VideoCD: CD-R/RW

For more details, refer to CyberLink web site: [http://www.gocyberlink.com/english/products/powerproducer/2\\_gold/comp\\_dvd\\_drives.jsp](http://www.gocyberlink.com/english/products/powerproducer/2_gold/comp_dvd_drives.jsp)

## ■ Macintosh

The following requirements must be satisfied to connect a camcorder to a PC.

**Hardware:** iMac, iBook, Power Mac G4 or G5, PowerBook G3 or G4, eMac equipped with a USB connector

**OS:** Mac OS 9.0.4 to 9.2.2, Mac OS X (10.1.5, 10.2.1 to 10.2.8, 10.3.1 to 10.3.5)

**RAM:** At least 64 MB (Mac OS 9), At least 128 MB (Mac OS X)

- 
- The system requirements information above is not a guarantee that the provided software will work on all personal computers meeting those requirements.
  - If your PC does not meet the system requirements above, you can use the optional USB reader/writer CU-VUSD70, the PC card adapter CU-VPD60 or the floppy disk adapter CU-VFSD50 to load the files in the memory card to the hard disk on your PC.  
(Refer to "JVC Accessories" on our world web site at: <http://www.jvc-victor.co.jp/english/accessory/>)
  - Microsoft® and Windows® are either registered trademarks or trademarks of Microsoft Corporation in the United States and/or other countries.
  - Macintosh is a registered trademark of Apple Computer, Inc.
  - Other product and company names included in this instruction manual are trademarks and/or registered trademarks of their respective holders.



## Software Installation (Windows®)

Follow the procedure described below to install the software. From the [SETUP] screen in step **2**, you can install the following drivers or software. Quit any other software you are using. (Check that there are no other application icons on the status bar.)

### USB Mass Storage Class driver

This driver allows your PC to read and write memory cards in the camcorder.

#### Windows® Me/2000/XP:

Since there is no need to install this driver, the item is not displayed. Simply connect the camcorder to the PC with a USB cable, and you can read and write memory cards in the camcorder.

#### Windows® 98SE:

Be sure NOT to connect the USB cable between the camcorder and the PC before installing the driver.

### CyberLink DVD Solution

#### PowerProducer 2 Gold

PowerProducer 2 Gold is software for creating movie discs incorporating not only video but also slideshows. This software uses a simple wizard format for creating a wide range of different format discs. You can also edit imported video. You can import video from the camera, edit it, and then create a slideshow from still images. You can create a customized menu for the video or slideshow and write the contents to DVD or other media.

### PowerDirector 3

PowerDirector 3 is software for easily capturing video from a camcorder and for easily editing MPEG, AVI, and other video files, still images, and other contents for creating a movie. This software has an interface that allows editing in either timeline or storyboard mode, maintains superior image quality, uses SVRT for high-speed rendering, and has a host of other advanced video editing features. You can export video files as DV format (AVI) to record on a DV tape.

#### NOTE:

If PowerProducer or PowerDirector is already installed, uninstall the software, then install the supplied CyberLink DVD Solution.

### Digital Photo Navigator 1.0

This application is used to organize still images and convert them into a variety of formats.

### G.726 decoder

This is an audio decoder for video clips created by the camcorder (extension “.asf”).

#### NOTE:

Install G.726 decoder only when the camcorder is equipped with E-Mail Clip Recording function.

## 1 Load the provided CD-ROM into the PC.

After a moment, the [SETUP] screen appears.

- From the [SETUP] screen, you can install the desired driver or software.
- If the [SETUP] screen does not appear, double-click the CD-ROM icon in the [My Computer] window.

## 2 Click [Install] on the right side of the desired software and follow the on screen instructions to complete the installation.

The installation of the selected driver or software starts. The procedure differs depending on the driver or the software.

## Following steps are the example of CyberLink DVD Solution on Windows® XP.

[Choose Setup Language] screen appears.



Select the desired language and click [OK].

Then, [CyberLink DVD Solution Setup] screen appears.

Click [Next].

[License Agreement] screen appears.

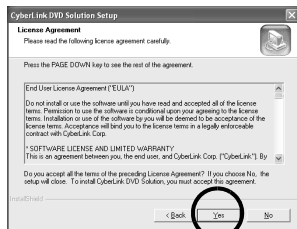

Click [Yes].

[Customer Information] screen appears.

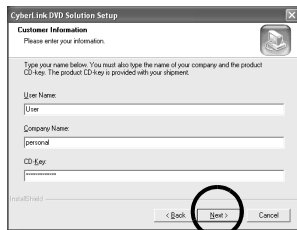

Confirm your information and click [Next].

- It is possible to change the information.

Then, [Choose Destination Location] screen appears.

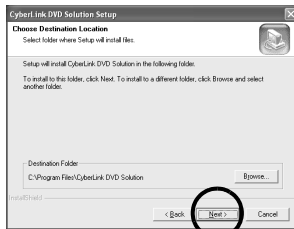

Click [Next].

[Setup Type] screen appears.

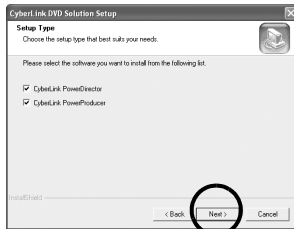

Select the program(s) you want to install, then click [Next].

Wait for a moment until the installation is finished.

When the installation is finished, [Setup Complete] screen appears.

Click [Finish]. Restarts the PC.

### For Windows® 98SE/Me/2000:

Before [Setup Complete] screen appears, [Question] screen appears.

Click [Yes]. Then, [DMA setting] screen appears. Click [OK].

[Setup Complete] screen appears. Click [Finish] to restart the PC.

### Install all of the desired software or driver in the same way.

To display [SETUP] screen, double-click the CD-ROM icon in the [My Computer] window.

### NOTE:

If you perform installation of a software that is already installed, uninstallation will start. In this case, perform the installation again after uninstallation is finished.

## Updating [Device Manager] (Windows® 98SE only)

If the camcorder is connected to the PC with the USB cable before installing [USB Mass Storage Class driver], the installation might not be performed properly.

In this case, follow the procedure described below to update the [Device Manager] and install [USB Mass Storage Class driver] properly.

### NOTE:

Disconnect any other USB audio devices from PC before performing the following procedure.

### Installing [USB Mass Storage Class driver]

- 1 Use the USB cable to connect the camcorder to the PC.**  
(☞ pg. 8)
- 2 Click [Start], go to [Settings], and then click [Control Panel]. Double click the [System] icon.**
- 3 Select the [Device Manager] tab.**
- 4 Delete [GR-D290\*] in [Other devices].**  
\* The model name depends on the connected camcorder.
- 5 Disconnect the USB cable from the camcorder. Restart the PC.**
- 6 Load the provided CD-ROM into the PC. Install [USB Mass Storage Class driver].** (☞ pg. 5)
- 7 Use the USB cable to connect the camcorder to the PC.**  
Device driver is installed.
- 8 Confirm the [Removable Disk] icon is displayed in [My Computer].**

# Connections (Windows®)

## Connecting the USB cable

Connect the USB cable to copy still image and video clip files in a memory card to the PC or to use PowerDirector 3 in capturing video.

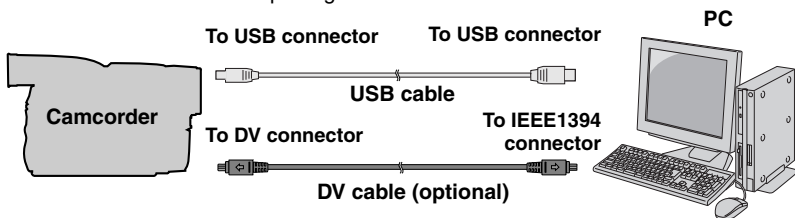

- 1 To assure safety, make sure all units are turned off before making any connections.**
- 2 Use the USB cable to connect the camcorder to the PC.**

### To create DVD Video:

- **For Windows® 98SE/Me/2000/XP:** Use a DV cable instead of a USB cable to capture video from a tape.
- **For Windows® XP:** In addition, you can capture DV pictures from a tape with USB connection (USB 2.0) even if the PC has no IEEE1394 connector. (The USB 1.1 connector on the PC cannot be used.)

### NOTES:

- **It is recommended to use the AC Adapter as the power supply instead of the battery pack.**
- When the USB cable or DV cable is connected, turning on or off the camcorder or switching the VIDEO/MEMORY (DSC) mode on the camcorder causes malfunctions of the PC.
- If PowerDirector 3 does not recognize the camcorder, exit PowerDirector 3 once, then start it again.
- If you connect the camcorder to the PC through a USB hub, compatibility issues between the hub and the PC may result in instability in the operation of the PC. If this happens, connect the camcorder directly to the PC, not through the hub.
- Do not use an extension USB cable.
- When connecting the camcorder to a PC using a DV cable, make sure to follow the procedure below. Connecting the cable incorrectly may cause malfunctions to the camcorder and/or the PC.
  - Connect the DV cable first to the PC, and then to the camcorder.
  - Connect the DV cable (plugs) correctly according to the shape of the DV connector.

## Viewing the Contents of a Memory Card (Windows®)

- 1 Install [USB Mass Storage Class driver]. (Windows® 98SE only) (☞ pg. 5)
- 2 Make sure that there is a memory card in the camcorder.
- 3 Set the camcorder's VIDEO/MEMORY Switch to "MEMORY".
- 4 Set the camcorder's Power Switch to "PLAY" while pressing down the Lock Button located on the switch.

The camcorder turns on.

- 5 Connect the camcorder to the PC with a USB cable. (☞ pg. 8)  
On the camcorder's LCD monitor [USB] appears.

- 6 When using Windows® XP:

The [Removable Disk] window appears on the PC's screen after a moment. Select [Open folders to view files using Windows Explorer] and click [OK].



### NOTE:

If the [Removable Disk] window does not appear, confirm the connection (☞ pg. 8) or perform the steps 1 and 2 in the right.

## When using Windows® 98SE/Me/2000:

- 1 Double-click the [My Computer] icon on the desktop. The [Removable Disk] icon which represents the memory card in the camcorder appears in the [My Computer] window.



- 2 Double-click the [Removable Disk] icon.

- Windows® 98SE: [Removable Disk] icon does not appear if USB Mass Storage Class driver is not installed properly. In this case, refer to "Updating [Device Manager] (Windows® 98SE only)" (☞ pg. 7).

- 7 The folders in the memory card appear.

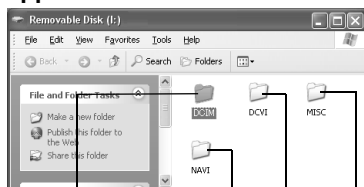

Still images

Navigation data

Video clips

DPOF setting data

Different file types are stored in different folders.

**[DCIM]:** Contains folders with still images (extension ".jpg")

**[DCVI]:** Contains folders with video clips (extension ".asf")

- The [DCVI] folder is displayed only when the camcorder is equipped with E-Mail Clip Recording function.

**[MISC]:** Contains folders with DPOF setting data

CONTINUED ON NEXT PAGE

[NAVI]: Contains folders with navigation data

- The [NAVI] folder is displayed only when the camcorder is equipped with NAVIGATION function.

#### NOTES:

- Saving the wrong kinds of files in a memory card or deleting files or folders from a memory card can cause problems with the operation of the camcorder. When it is necessary to delete a file from a memory card, delete it through the camcorder.
- Never disconnect the USB cable while “▶▶▶▶▶” is displayed on the camcorder’s LCD monitor.
- If you are using a brand new memory card, you need to initialize the memory card with the camcorder first. You may not be able to copy files from the memory card to the PC without doing so.
- The file extension may not appear depending on the [FOLDER] option setting of Windows®.

## Copying Files to the PC (Windows®)

Still image and video clip files that are stored in a memory card can be copied to the PC and played back on the PC.

- 1 Perform the procedure in “Viewing the Contents of a Memory Card (Windows®)” (pg. 9).

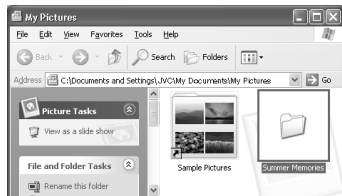

The folders in the memory card appear.

- 2 Create a new folder, enter the folder name, and then double-click it.
  - For example, create a new folder in the [My Pictures] folder.
- 3 Select the folder to be copied, and then drag and drop that folder in the destination folder.

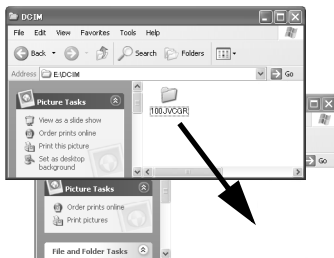

- To copy still images: Copy the folder within the [DCIM] folder.
  - To copy video clips: Copy the folder within the [DCVI] folder.
- “▶▶▶▶▶” appears on the LCD monitor of the camcorder, and the folder is copied from the memory card to the PC.

#### NOTE:

Never disconnect the USB cable while “▶▶▶▶▶” is displayed on the camcorder’s LCD monitor.

## Playing Back Files on the PC (Windows®)

### Still images

Use an application that can handle the JPEG file format. To view a still image, double-click the still image file (extension “.jpg”).

### Video clips (Only for the camcorder equipped with E-Mail Clip Recording function)

Use the Windows Media™ Player (version 6.4 or later). You can download the Windows Media™ Player from the Microsoft web site at: <http://www.microsoft.com/>

If you cannot play back a video clip file (extension “.asf”) that you have opened with the Windows Media™ Player, connect to the Internet and then try opening the file. The software that is needed in order to play back the file will be downloaded automatically, and then the file will be played back.

If the video clip plays but without the audio, install the G.726 decoder from the CD-ROM.

## Disconnecting the USB Cable (Windows®)

Before loading or unloading memory cards or turning off the PC, first disconnect the USB cable and turn off the camcorder.

### When using Windows® 98SE

- 1 Confirm that “▶▶▶▶▶” is not currently displayed on the LCD monitor of the camcorder.**
  - If “▶▶▶▶▶” is currently displayed, wait until it disappears before proceeding.
- 2 Double-click the [My Computer] icon on the desktop.**

If the camcorder is connected to the PC correctly, the [Removable Disk] icon appears.
- 3 Right-click the [Removable Disk] icon in the [My Computer] window.**

A menu appears.

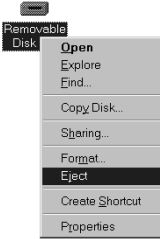
- 4 Click [Eject] in the menu.**

The [Removable Disk] icon disappears.

  - If the icon does not disappear, wait for a while, and then proceed to step 5.
- 5 Disconnect the USB cable.**
  - If any message appears, click [OK].
- 6 Set the camcorder's Power Switch to “OFF”.**

The camcorder turns off.

## When using Windows® 2000/Me/XP

**1** Confirm that “▶▶▶▶▶” is not currently displayed on the LCD monitor of the camcorder.

- If “▶▶▶▶▶” is currently displayed, wait until it disappears before proceeding.

**2** Double-click the [Safely Remove Hardware] or [Unplug or Eject Hardware] icon in the status bar.



[Remove Hardware] or [Unplug or Eject Hardware] dialog box appears.

The [Safely Remove Hardware] or [Unplug or Eject Hardware] dialog box appears.

**Windows® XP:** If not, wait a while then go to step 5.

**3** Select [USB Mass Storage Device] or [USB Disk], and then click [Stop].

• **Windows® 2000/XP**



• **Windows® Me**

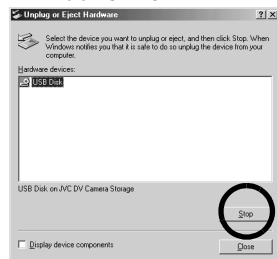

The [Stop a Hardware device] dialog box appears.

**4** Click [OK].

**Windows® 2000/Me:** If a message indicating that the device can be safely removed appears, click [OK] and then click [Close].

• **Windows® 2000/XP**



• **Windows® Me**



The model name depends on the connected camcorder.

**5** Disconnect the USB cable.

**6** Set the camcorder's Power Switch to “OFF”.

The camcorder turns off.



## Connections (Macintosh)

Connect the USB cable to copy still image or video clip files in a memory card to the PC.

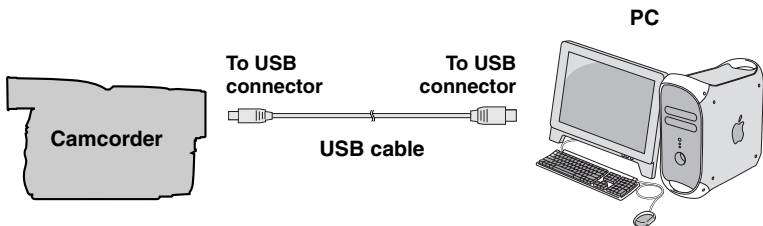

- 1 To assure safety, make sure all units are turned off before making any connections.**
- 2 Use the USB cable to connect the camcorder to the PC.**

### NOTES:

- It is recommended to use the AC Adapter as the power supply instead of the battery pack.
- When the USB cable is connected, turning on or off the camcorder or switching the VIDEO/MEMORY (DSC) mode on the camcorder causes malfunctions of the PC.
- If you connect the camcorder to the PC through a USB hub, compatibility issues between the hub and the PC may result in instability in the operation of the PC. If this happens, connect the camcorder directly to the PC, not through the hub.
- Do not use an extension USB cable.

## Viewing the Contents of a Memory Card (Macintosh)

- 1 Make sure that there is a memory card in the camcorder.**
- 2 Set the camcorder's VIDEO/MEMORY Switch to "MEMORY".**
- 3 Set the camcorder's Power Switch to "PLAY" while pressing down the Lock Button located on the switch.**
- 4 Connect the camcorder to the PC with a USB cable. (See above)**

On the camcorder's LCD monitor [USB] appears. The memory card icon appears on the desktop.

  - The name of the memory card icon is "Untitled", "Unlabeled" or "No name". We recommend that you name the icon to tell it from the other removable disks or folders.
- 5 Double-click the memory card icon on the desktop.**



The folders in the memory card appear.

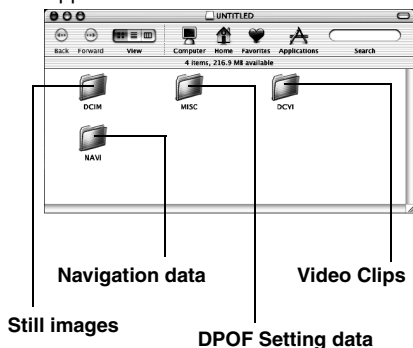

Different file types are stored in different folders.

**[DCIM]:** Contains folders with still images (extension “.jpg”)

**[DCVI]:** Contains folders with video clips (extension “.asf”)

- The [DCVI] folder is displayed only when the camcorder is equipped with E-Mail Clip Recording function.

**[MISC]:** Contains folders with DPOF setting data

**[NAVI]:** Contains folders with navigation data

- The [NAVI] folder is displayed only when the camcorder is equipped with NAVIGATION function.

## NOTES:

- Saving the wrong kinds of files in a memory card or deleting files or folders from a memory card can cause problems with the operation of the camcorder. When it is necessary to delete a file from a memory card, delete it through the camcorder.
- Never disconnect the USB cable while “▶▶▶▶▶” is displayed on the camcorder’s LCD monitor.
- If you are using a brand new memory card, you need to initialize the memory card with the camcorder first. You may not be able to copy files from the memory card to the PC without doing so.

## Copying Files to the PC (Macintosh)

Still image and video clip files that are stored in a memory card can be copied to the PC and played back on the PC.

- 1 Double-click the memory card icon on the desktop.**  
The folders in the memory card appear.
- 2 Create a new folder, enter the folder name, and then double-click it.**
- 3 Select the folder to be copied, and then drag and drop that folder in the destination folder.**

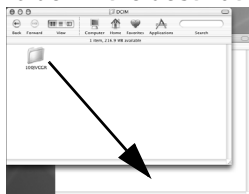

- To copy still images: Copy the folder within the [DCIM] folder.
  - To copy video clips: Copy the folder within the [DCVI] folder.
- “▶▶▶▶▶” appears on the LCD monitor of the camcorder, and the folder is copied from the memory card to the PC.

## NOTE:

Never disconnect the USB cable while “▶▶▶▶▶” is displayed on the camcorder’s LCD monitor.

## Playing Back Files on the PC (Macintosh)

### Still images

Use an application that can handle the JPEG file format. To view a still image, either double-click the still image file (extension “.jpg”), or drag and drop the file on the application icon.

### Video clips (Only for the camcorder equipped with E-Mail Clip Recording function)

Use the Windows Media™ Player for Mac (version 6.4 or later). You can download the Windows Media™ Player for Mac from the Microsoft web site at:

<http://www.microsoft.com/>

## Disconnecting the USB cable (Macintosh)

Before loading or unloading memory cards or turning off the PC, first disconnect the USB cable and turn off the camcorder.

### 1 Drop the memory card icon on the desktop into the [Trash] icon.

- If the confirmation message appears, click [OK].

### 2 Confirm that “▶▶▶▶▶” is not currently displayed on the LCD monitor of the camcorder.

- If “▶▶▶▶▶” is currently displayed, wait until it disappears before proceeding.

### 3 Disconnect the USB cable.

### 4 Set the camcorder's Power Switch to “OFF”.

The camcorder turns off.



## User's Guide/Help/Readme

This manual only refers to software installation and PC connection. For more details of each software, refer to its user's guide/help/Readme.

### ■ CyberLink DVD Solution

Following steps are the example of CyberLink PowerDirector 3.

- 1 Click [Start], go to [All Programs] or [Programs] – [CyberLink DVD Solution] – [PowerDirector], and then click **User's Guide/Help/Readme** depending on your preference.

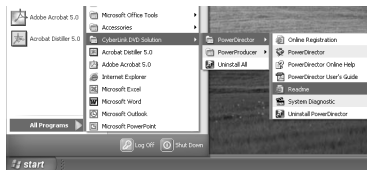

### INFORMATION

The programs in CyberLink DVD Solution are versions with limited functionality. The User's Guide and Help files are written for the commercial version available in stores. For information about the differences with the commercial version, see the Readme file for the respective program.

### ■ Digital Photo Navigator

- The instruction manual is included on the CD-ROM in PDF format. Right-click the CD-ROM icon in [My Computer], then click [Open]. Double-click the [Docs] folder. Open the “Start.pdf” file and click the button of the desired language. Note that Adobe® Acrobat® Reader™ or Adobe® Reader® must be installed to read PDF files.
- Adobe® Reader® can be loaded from Adobe's web site: <http://www.adobe.com/>

# Overview of Enjoying the Moving or Still Images on the PC

## Moving images

**SHOOT** the moving images

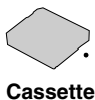

Cassette



**TRANSFER** the moving images via the USB or DV cable with PowerDirector 3

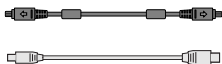

**EDIT** moving images with PowerDirector 3

**CREATE** the DVD or VCD with PowerProducer 2 Gold



**PLAYBACK** the DVD or VCD

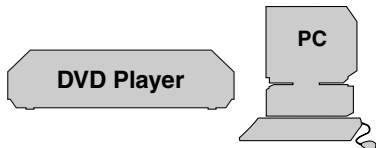

## Still images

**SHOOT** the still images



Memory Card



**TRANSFER** the still images via the USB cable



**CREATE** and **ENJOY** the picture album with Digital Photo Navigator 1.0

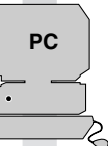
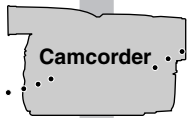

Use of PowerProducer 2 Gold alone is enough for creating a DVD or VCD with ease.  
<http://www2.cli.co.jp/products/dvc/>